

OPERATIONS
MANUAL

unity 

UNITY:

COMPLETE HOME
ENTERTAINMENT
DVD SYSTEM

BOSTON | KENWOOD



Before applying power

 **Caution : Read this page carefully to ensure safe operation.**

Units are designed for operation as follows.





U.S.A. and Canada AC 120V only

Preparations

Safety precautions





 **Caution : Read this page carefully to ensure safe operation.**

WARNING : TO PREVENT FIRE OR ELECTRIC SHOCK, DO NOT EXPOSE THIS APPLIANCE TO RAIN OR MOISTURE.

	CAUTION RISK OF ELECTRIC SHOCK DO NOT OPEN		CAUTION: TO REDUCE THE RISK OF ELECTRIC SHOCK, DO NOT REMOVE COVER (OR BACK). NO USER-SERVICEABLE PARTS INSIDE, REFER SERVICING TO QUALIFIED SERVICE PERSONNEL.
	THE LIGHTNING FLASH WITH ARROWHEAD SYMBOL, WITHIN AN EQUILATERAL TRIANGLE, IS INTENDED TO ALERT THE USER TO THE PRESENCE OF UNINSULATED "DANGEROUS VOLTAGE" WITHIN THE PRODUCT'S ENCLOSURE THAT MAY BE OF SUFFICIENT MAGNITUDE TO CONSTITUTE A RISK OF ELECTRIC SHOCK TO PERSONS.		
	THE EXCLAMATION POINT WITHIN AN EQUILATERAL TRIANGLE IS INTENDED TO ALERT THE USER TO THE PRESENCE OF IMPORTANT OPERATING AND MAINTENANCE (SERVICING) INSTRUCTIONS IN THE LITERATURE ACCOMPANYING THE APPLIANCE.		

Caution : Read the pages marked  carefully to ensure safe operation.

Preparations

Introduction	2
 Before applying power	2
 Safety precautions	2
Accessories	4
 IMPORTANT SAFEGUARDS	5
Special features and Contents	7
Special features	7
Reference	7
Maintenance	8
Discs information	9
Types of playable discs	9
Unplayable discs	9
Icons on the DVD discs	9
 System Connections	10
Back of the Receiver	10
Loudspeakers	11
AM loop antenna	12
FM antenna	12
Connecting to a TV	13
Connecting to a Satellite Tuner or Cable Tuner	13
Connecting to Audio video equipments	14
Connecting a Camcorder or Video game machine	14
Controls and indicators	15
Operation of remote control unit	16

Operations

Let's put out some sound	17
Basic use method	17
Receiving broadcast station	19
Storing the broadcast stations (one-by-one presetting)	20
Playback of disc	21
Basic play	21
Disc playback features	22
Using the On-screen banner display	23
Selecting a Title	24
Selecting a Chapter or Track	24
Changing the Audio Language	25
Changing the Subtitle Language	25
Changing the Camera angle	26
Using IntroScan function	26
Using Bookmarks	27
Repeat play	28
A-B Repeat play	28
Random play	29
Program play	30
Menu playback	32
Hierarchical structure of VCD menus	32
Examples of operation keys and indications used during VCD playback	32
Playback without using the menu playback function (In case of a P.B.C.-compatible VCD) (To P.B.C. On or Off)	33
MP3 function	34
Guidance of MP3	34
MP3 On-screen display	35
Playing back MP3	35
Selecting MP3 files or folders	36
MP3 program playback	37

Set Up functions	38
Set up menu	38
Select Audio Language	39
Select Subtitle Language	39
Select Menu Language	40
Select Rating	40
Password	41
TV aspect	43
Setting up LISTEN mode	44
What are LISTEN modes?	44
To set the LISTEN mode manually	45
Speaker setting	46
Speaker level setting	47
Level setting using a music source	48
Changing the INPUT MODE	48
Control of a different device with the accessory remote controller ...	49
Register the setup codes for your audio and video	49
Operating other devices	49
Setup code table	50
Keys which can be used to operate connected devices	53

Knowledge

Knowledge	54
DVD menu language code list	54
In case of difficulty	55
Specifications	58

Unpacking

Unpack the unit carefully and make sure that all accessories are put aside so they will not be lost.

Examine the unit for any possibility of shipping damage. If your unit is damaged or fails to operate, notify your dealer immediately. If your unit was shipped to you directly, notify the shipping company without delay. Only the consignee (the person or company receiving the unit) can file a claim against the carrier for shipping damage.

We recommend that you retain the original carton and packing materials for use should you transport or ship the unit in the future.

Keep this manual handy for future reference.

Accessories

Please confirm that the following accessories are present.

Accessories packed with the main unit

FM indoor antenna (1)

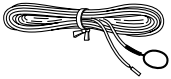

Loop antenna (1)

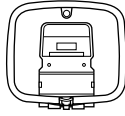

Video cord (1)

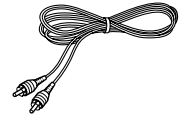

Remote control unit (1)

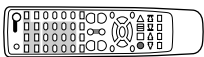

Batteries (LR03/AAA) (2)

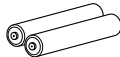

Speaker cords (5)



Please read all of the safety and operating instructions before operating this appliance. Adhere to all warnings on the appliance and in the instruction manual. Follow all the safety and operating instructions. These safety and operating instructions should be retained for future reference.

1. Power sources – The appliance should be connected to a power supply only of the type described in the instruction manual or as marked on the appliance. If you are not sure of the type of power supply to your home, consult your appliance dealer or local power company. For appliances intended to operate from battery power, or other sources, refer to the instruction manual.

2. Power-cord protection – Power-supply cords should be routed so that they are not likely to be walked on or pinched by items placed upon or against them, pay particular attention to cords at plugs, convenience receptacles, and the point where they exit from the appliance.

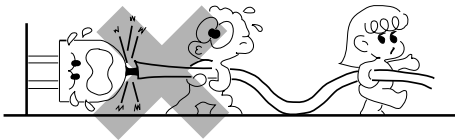

3. CAUTION – Polarization – This appliance may be equipped with a polarized alternating-current line plug (a plug having one blade wider than the other). This plug will fit into the power outlet only one way. This is a safety feature. If you are unable to insert the plug fully into the outlet, try reversing the plug. If the plug should still fail to fit, contact your electrician to replace your obsolete outlet. Do not defeat the safety purpose of the polarized plug.

4. Ventilation – Slots and openings in the cabinet are provided for ventilation and to ensure reliable operation of the appliance and to protect it from overheating, and these openings must not be blocked or covered. The appliance should be situated so that its location or position does not interfere with its proper ventilation.

To maintain good ventilation, do not put records or a tablecloth on the appliance. Place the appliance at least 10 cm away from the walls.

Do not use the appliance on a bed, sofa, rug or similar surface that may block the ventilation openings. This appliance should not be placed in a built-in installation such as a bookcase or rack unless proper ventilation is provided or the manufacturer's instructions have been adhered to.

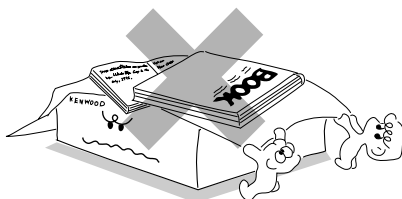

5. Water and moisture – The appliance should not be used near water - for example, near a bathtub, washbowl, kitchen sink, laundry tub, in a wet basement, or near a swimming pool, etc.

6. Temperature – The appliance may not function properly if used at extremely low, or freezing temperatures. The ideal ambient temperature is above +5°C (41°F).

7. Heat – The appliance should be situated away from heat sources such as radiators, heat registers, stoves, or other appliances (including amplifiers) that produce heat.

8. Electric shock – Care should be taken so that objects do not fall and liquid is not spilled into the enclosure through openings. If a metal objects, such as a hair pin or a needle, comes into contact with the inside of this appliance, a dangerous electric shock may result. For families with children, never permit children to put anything, especially metal, inside this appliance.

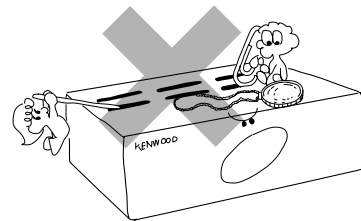

9. Enclosure removal – Never remove the enclosure. If the internal parts are touched accidentally, a serious electric shock might occur.

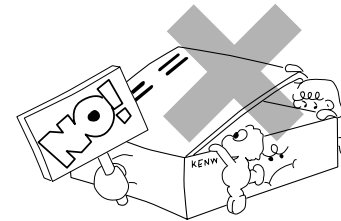

10. Magnetic fields – Keep the appliance away from sources of magnetic fields such as TV sets, speaker systems, radios, motorized toys or magnetized objects.

11. Cleaning – Unplug this appliance from the wall outlet before cleaning. Do not use volatile solvents such as alcohol, paint thinner, gasoline, or benzene, etc. to clean the cabinet. Use a clean dry cloth.

12. Accessories – Do not place this appliance on an unstable cart, stand, tripod, bracket, or table. The appliance may fall, causing serious injury to a child or adult, and serious damage to the appliance. Use only with a cart, stand, tripod, bracket, or table recommended by the manufacturer, or sold with the appliance. Any mounting of the appliance should follow the manufacturer's instructions, and should use a mounting accessory recommended by the manufacturer. An appliance and cart combination should be moved with care. Quick stops, excessive force, and uneven surfaces may cause the appliance and cart combination to overturn.



13. Lightning – For added protection for this appliance during a lightning storm, or when it is left unattended and unused for long periods of time, unplug it from the wall outlet and disconnect the antenna or cable system. This will prevent damage to the appliance due to lightning and power-line surges.

14. Abnormal smell – If an abnormal smell or smoke is detected, immediately turn the power OFF and unplug the appliance from the wall outlet. Contact your dealer or nearest service center.

POWER OFF!

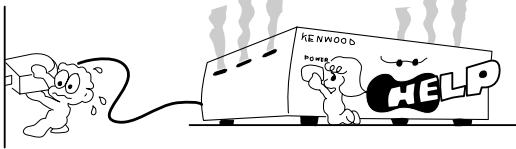

15. Damage requiring service – The appliance should be serviced by qualified service personnel when:

- A.** The power-supply cord or the plug has been damaged.
- B.** Objects have fallen, or liquid has been spilled into the appliance.
- C.** The appliance has been exposed to rain or water.
- D.** The appliance does not appear to operate normally by following the instruction manual. Adjust only those controls that are covered by the instruction manual as an improper adjustment of other controls may result in damage and will often require extensive work by a qualified technician to restore the appliance to its normal operation.
- E.** The appliance has been dropped, or the enclosure damaged.
- F.** The appliance exhibits a marked change in performance.

16. Servicing – The user should not attempt to service the appliance beyond that described in the instruction manual. All other servicing should be referred to qualified service personnel.

17. Outdoor antenna grounding – If an outside antenna is connected to the appliance, be sure the antenna system is grounded so as to provide some protection against voltage surges and built up static charges. Article 810 of the National Electrical Code ANSI/NFPA 70, provides information with respect to proper grounding of the mast and supporting structure, grounding of the lead-in wire to an antenna discharge unit, size of grounding conductors, location of antenna discharge unit, connection to grounding electrodes, and requirements for the grounding electrode. See Figure.

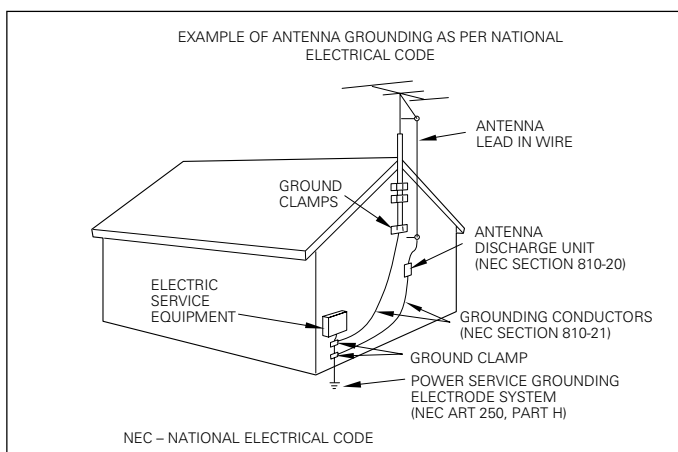

18. Power lines – An outside antenna system should not be located in the vicinity of overhead power lines or other electric light or power circuits, or where it can fall into such power lines or circuits. When installing an outside antenna system, extreme care should be taken to keep from touching such power lines or circuits as contact with them might be fatal.

19. AC outlets – Do not connect other audio equipment with a power consumption larger than that specified to the AC outlet on the rear panel. Never connect other electrical appliances, such as an iron or toaster, to it to prevent fire or electric shock.

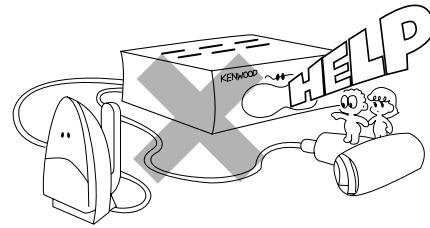

20. Overloading – Do not overload wall outlets, extension cords, or integral convenience receptacles as this can result in a risk of fire or electric shock.

21. Attachment – Do not use attachments not recommended by the appliance manufacturer as they may cause hazards.

22. Replacement parts – When replacement parts are required, be sure the service technician has used replacement parts specified by the manufacturer or have the same characteristics as the original parts. Unauthorized substitutions may result in fire, electric shock, or other hazards.

23. Safety check – Upon completion of any service or repairs to this appliance, ask the service technician to perform safety checks to determine that the appliance is in proper operating condition.

Notes:

1. Item 3 is not required except for grounded or polarized equipment.
2. Item 17 and 18 are not required except for units provided with antenna terminals.
3. Item 17 complies with UL in the U.S.A.

Special features

This document classifies the applications of each feature using the following marks

DVD : Description of a feature that can be used with DVD.

CD : Description of a feature that can be used with CD.

VCD : Description of a feature that can be used with VCD.



DVD *Higher video quality than S-VHS video and LaserDisc*

DVD *Higher audio quality than music CD*

DVD **CD** **VCD** *Graphical user interface (GUI) compatibility*

DVD *Versatile DVD playback features*

DVD **CD** *The DVR-5070 offers DTS decoder.*

DVD **CD** **VCD** *Dolby Pro Logic II decoder.*

Reference

Caution on condensation

Condensation (of dew) may occur inside the unit when there is a great difference in temperature between this unit and the outside.

This unit may not function properly if condensation occurs. In this case, leave the unit for a few hours with the power left ON, and restart the operation after the condensation has dried up.

Be specially cautious against condensation in a following circumstance:

When this unit is carried from a place to another across a large difference in temperature, when the humidity in the room where this unit is installed increases, etc.

Note related to transportation and movement

Before transporting or moving this unit, carry out the following operations.

❶ Remove the disc from the unit.

❷ Press the ►/II key.

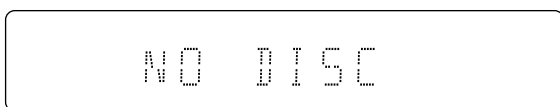

❸ Wait a few seconds and turn the unit OFF.

Memory backup function

Stored contents which are cleared in at least a week after power plug is unplugged from power outlet.

Amplifier section

Last input selection
Volume control value
Surround setting

Tuner section

Receiving band
Frequency
Preset stations
Tuning mode setting

DVD section

Menu setup

Power status

WARNING NOTICE:

IN MOST CASES IT IS AN INFRINGEMENT OF COPYRIGHT TO MAKE COPIES OF TAPES OR DISCS WITHOUT THE PERMISSION OF THE COPYRIGHT OWNERS. ANYONE WISHING TO COPY COMMERCIALY AVAILABLE TAPES OR DISC SHOULD CONTACT THE MECHANICAL COPYRIGHT PROTECTION SOCIETY LIMITED OR THE PERFORMING RIGHTS SOCIETY LIMITED.

Maintenance of the Set

When the front panel, the case, etc. becomes dirty, wipe with a soft, dry cloth. Do not use thinner, alcohol, etc., as these can cause discoloration.

In regard to contact cleaners

Do not use contact cleaners because it could cause a malfunction. Be specially careful not to use contact cleaners containing oil, for they may deform the plastic component.

Disc handling precautions

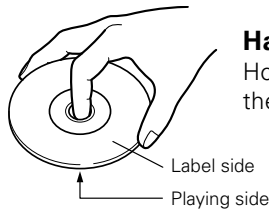

Handling

Hold the discs so that you do not touch the playing surface.

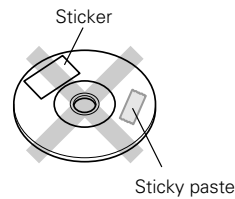

Do not attach paper or tape to either the playing side or the label side of the discs.

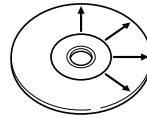

Cleaning

If fingerprints or foreign matter become attached to the disc, lightly wipe the disc with a soft cotton cloth (or similar) from the center of the disc outwards in a radial manner.

Storage

When a disc is not to be played for a long period of time, remove it from the player and store it in its case.

Never play a cracked or warped disc

During playback, the disc rotates at high speed in the player. Therefore, to avoid danger, never use a cracked or deformed disc or a disc repaired with tape or adhesive agent. Please do not use discs which are not round because they may cause a malfunction.

Disc accessories

The disc accessories (stabilizer, protection sheet, protection ring, etc.) which are marketed for improving the sound quality or protecting discs as well as the disc cleaner should not be used with this system because they may cause malfunction.

For the U.S.A.

CAUTION:

Use of controls or adjustments or performance of procedures other than those specified herein may result in hazardous radiation exposure.

In compliance with Federal Regulations, following are reproductions of labels on, or inside the product relating to laser product safety.

KENWOOD CORPORATION
2967-3, ISHIKAWA-CHO,
HACHIOJI-SHI,
TOKYO, JAPAN

KENWOOD CORP. CERTIFIES THIS EQUIPMENT CONFORMS TO
DHHS REGULATIONS NO. 21 CFR
1040.10, CHAPTER 1, SUBCHAPTER J.

Location: Back Panel

CAUTION- LASER RADIATION WHEN OPEN.
DO NOT STARE INTO BEAM.

Location: Laser Pick-up Unit Cover inside this product

For the U.S.A.

FCC WARNING

This equipment may generate or use radio frequency energy. Changes or modifications to this equipment may cause harmful interference unless the modifications are expressly approved in the instruction manual. The user could lose the authority to operate this equipment if an unauthorized change or modification is made.

NOTE:

This equipment has been tested and found to comply with the limits for a Class B digital device, pursuant to Part 15 of the FCC Rules. These limits are designed to provide reasonable protection against harmful interference in a residential installation. This equipment may cause harmful interference to radio communications, if it is not installed and used in accordance with the instructions. However, there is no guarantee that interference will not occur in a particular installation. If this equipment does cause harmful interference to radio or television reception, which can be determined by turning the equipment off and on, the user is encouraged to try to correct the interference by one or more of the following measures:

- Reorient or relocate the receiving antenna.
- Increase the separation between the equipment and receiver.
- Connect the equipment into an outlet on a circuit different from that to which the receiver is connected.
- Consult the dealer or an experienced radio / TV technician for help.

Types of playable discs

The system using this unit does not only play music from CD but can also play the discs listed below to offer you high-quality entertainment of video of movies and live concerts.

Playable Disc		DVD		CD		VCD
Logo mark on disc						
Disc size						
Played sides		One or both	One or both	One side only	One side only	One side only
Contents	Video + Audio	Approx. 41 min. (1 side, 1 layer) Approx. 75 min. (1 side, 2 layers) Approx. 82 min. (2 sides, 1 layer) Approx. 150 min. (2 sides, 2 layers)	Approx. 133 min. (1 side, 1 layer) Approx. 242 min. (1 side, 2 layers) Approx. 266 min. (2 sides, 1 layer) Approx. 484 min. (2 sides, 2 layers)	/		Max. 74 min.
	Audio	/				

Unplayable discs

This player cannot play back any of the following discs.

- DVD-ROM discs
- DVD-R/DVD-RAM/DVD-RW discs
- VSD discs
- CDV discs (only the audio part can be reproduced.)
- CD-ROM discs (except MP3 (ISO 9660 level 1 format) disc.)
- CD-G/CD-EG/CD-EXTRA discs (only the audio can be reproduced.)
- Photo CD discs (never attempt to play them.)
- S-VCD discs

Icons on the DVD discs

Icon	Description
	Indicates the region code where the disc can be played.
	Number of voice languages recorded with the audio function. The number in the icon indicates the number of voice languages. (Max. 8 languages)
	Number of subtitle languages recorded with the subtitle function. The number in the icon indicates the number of subtitle languages. (Max. 32 languages)
	Number of angles provided by the angle function. The number in the icon indicates the number of angles. (Max. 9 angles)
	Aspect ratios that can be selected. "LB" stands for Letter Box and "PS" for Pan/Scan. In the example on the left, the 16:9 video can be converted into letter box video.

Restrictions due to difference between discs

Some DVD discs can be played only in certain playback modes according to the intentions of the software producers. As this player plays discs according to their intentions, some functions may not work as intended by you. Please be sure to read the instructions provided with each disc. When an inhibition icon is displayed on the TV screen connected to the player, it indicates that the disc being played is under the restriction as described above.

Inhibition icon



When connecting the related system components, refer also to the instruction manuals of the related components.

Caution:

Do not plug in the power lead until all connections are completed.

Caution

Be sure to adhere followings. Or proper ventilation will be blocked causing damage or fire hazard.

- Do not place any objects impairing heat radiation onto the top of unit.
- Leave a space around the unit (from the largest outside dimension including projection) equal or greater than, shown below.

Top panel : 50 cm Side panel : 10 cm Back panel : 10 cm

Malfunction of microcomputer

If operation is not possible or erroneous display appears even though all connections have been made properly, reset the microcomputer referring to "In case of difficulty".

Back of the Receiver

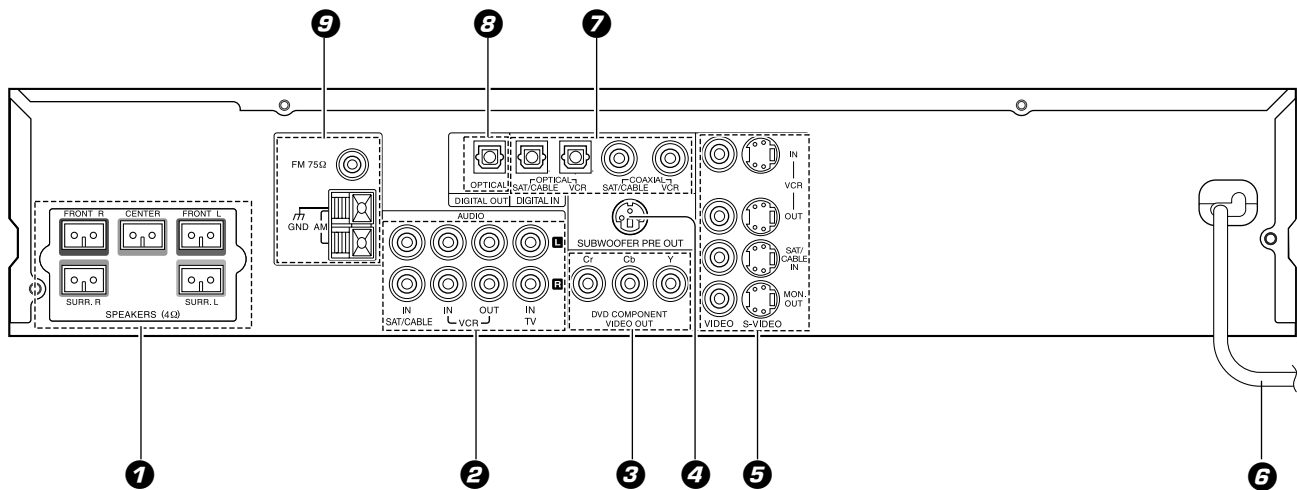

① **SPEAKER** terminals

② **AUDIO** input/output terminals

SAT/CABLE IN (SATELLITE or CABLE input) terminals

VCR IN/OUT terminals

Analog recording of DTS-encoded discs is not possible.

TV IN terminals

③ **DVD COMPONENT VIDEO OUT** terminals

④ **SUBWOOFER PRE OUT** terminal

⑤ **VIDEO (Composit) / S-VIDEO** input/output terminals

VCR IN/OUT terminals

SAT/CABLE IN (SATELLITE or CABLE input) terminals

MON. OUT (MONITOR output) terminals

⑥ **AC** cable

⑦ **DIGITAL IN** terminals

OPTICAL input terminals

SAT/CABLE (SATELLITE or CABLE) terminal

VCR terminal

COAXIAL input terminals

SAT/CABLE (SATELLITE or CABLE) terminal

VCR terminal

⑧ **DIGITAL OUT OPTICAL** terminal

Digital out signal is PCM format. Use for digital recording with an MD recorder or a CD recorder

⑨ **Antenna** terminals

Loudspeakers

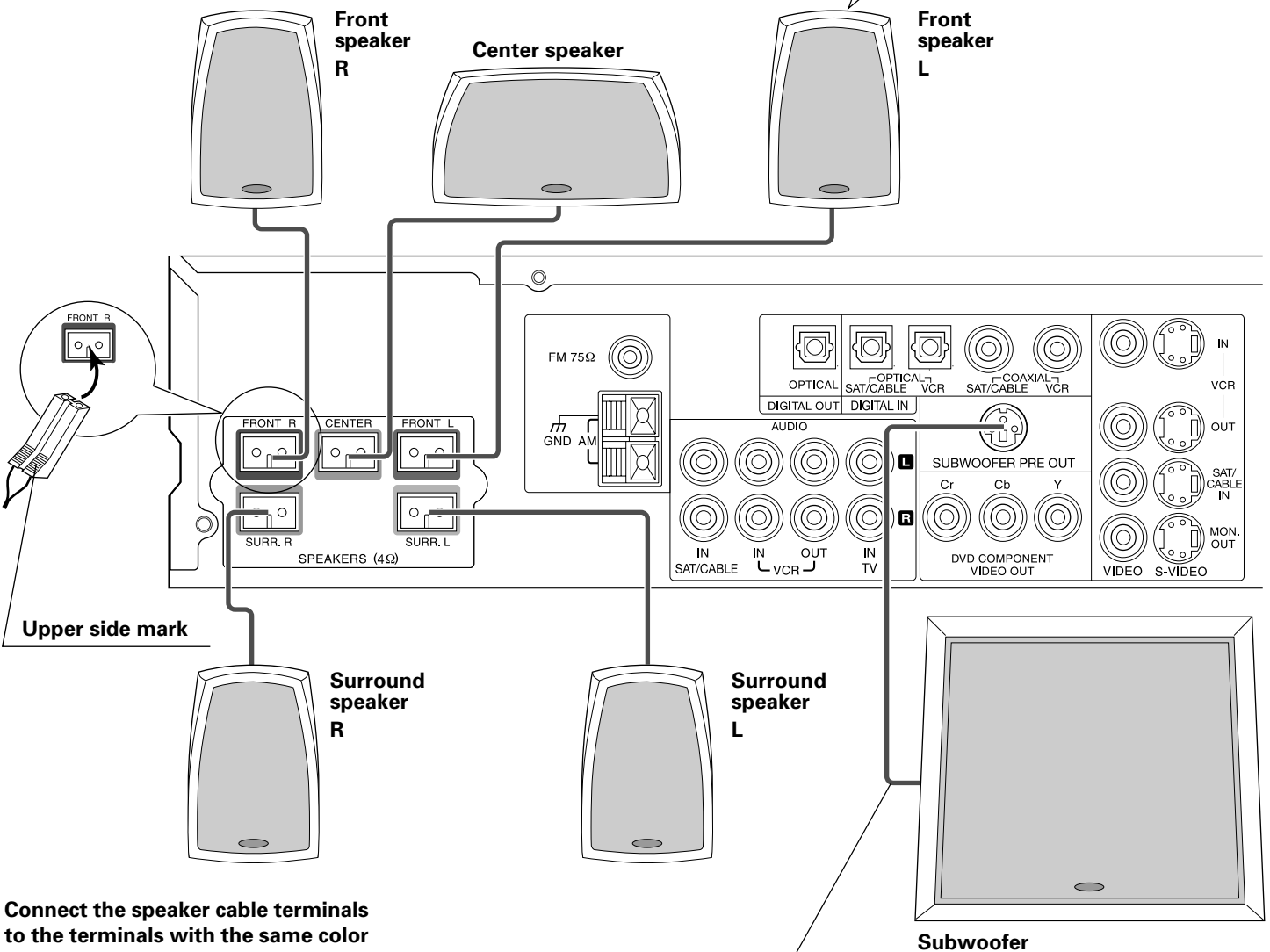
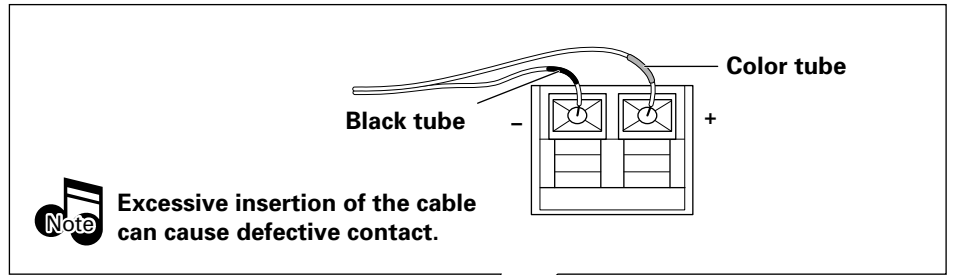
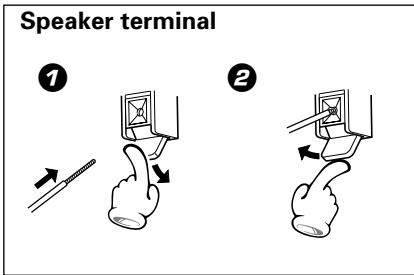

Connect the speaker cable terminals to the terminals with the same color at the speaker terminal panel on the main unit. Connect matching the color of the speaker terminal (+ side) and the color of the speaker cable tube.

Speaker	Color of the speaker terminal panel on the main unit
Front right	Red
Center	Green
Front left	White
Surround right	Gray
Surround left	Blue

Subwoofer cable:
Packed with speaker unit

⚠ Caution : Read this page carefully to ensure safe operation.

AM loop antenna

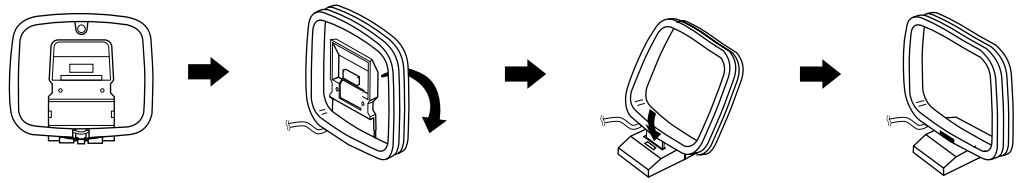

AM loop antenna connection

The supplied antenna is for indoor use. Place it as far as possible from the main system, TV set, speaker cords and power cord, and set it to a direction which provides the best reception.

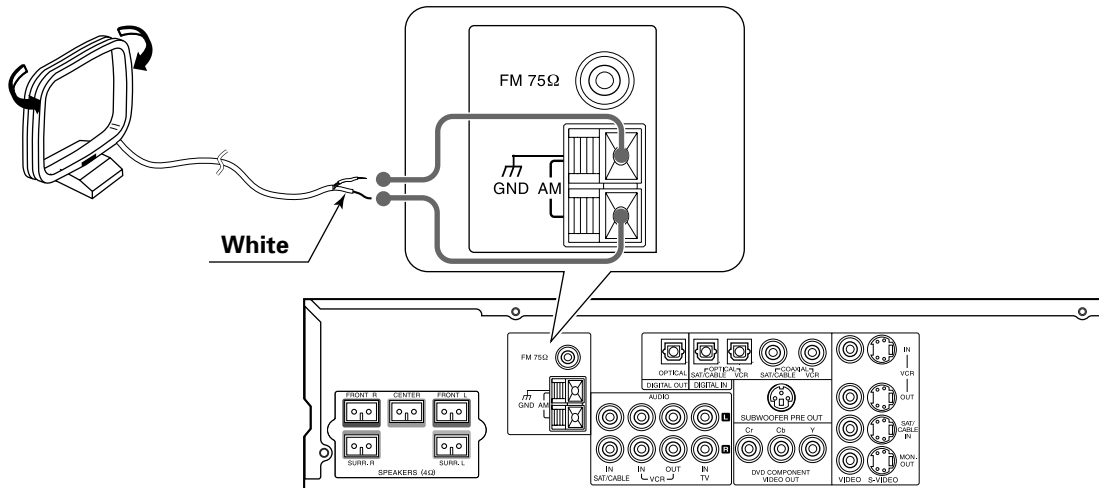

FM antenna

FM indoor antenna connection

The accessory antenna is for temporary indoor use only. For stable signal reception we recommend using an outdoor antenna. Remove the indoor antenna if you connect one outdoors.

- ❶ Connect to the antenna terminal.
- ❷ Locate the position providing good reception condition.
- ❸ Fix the antenna.

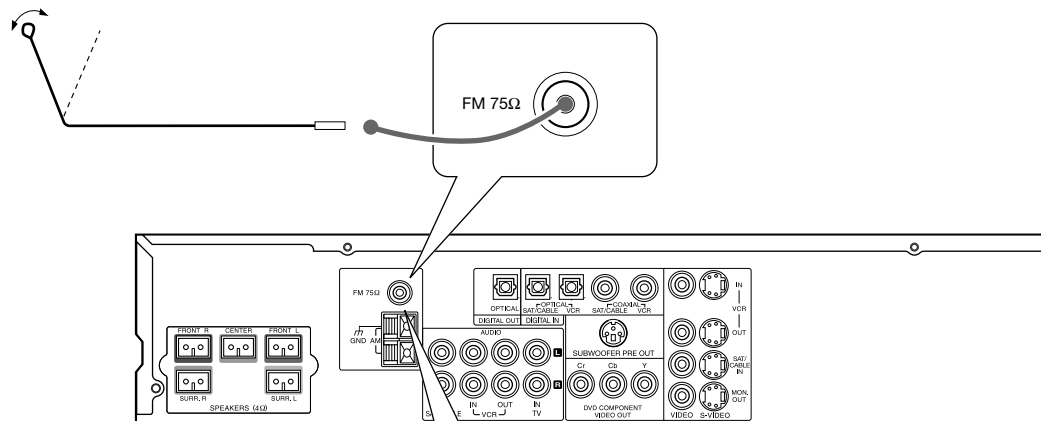

FM outdoor antenna (commercially available)

Lead the 75 Ω coaxial cable connected to the FM outdoor antenna into the room and connect it to the FM 75 Ω terminal.

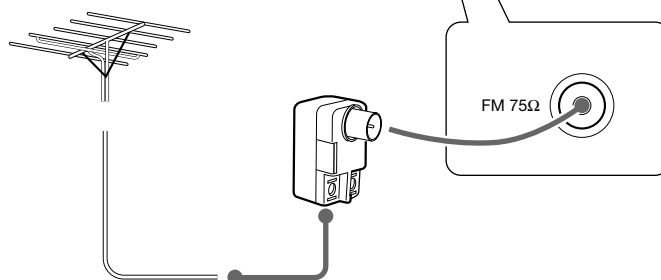

Connecting to a TV

Depending on the input switching, the output from the MONITOR OUT terminal will be one of the following signals. Please note that a different signal type will not be put out.

S-VIDEO terminal : S-video signal connected to the (S-VIDEO) VCR IN, the (S-VIDEO) SAT IN, or the AV AUX S terminal.

VIDEO terminal : Composite video signal connected to the (VIDEO) VCR IN, the (VIDEO) SAT IN, or the AV AUX VIDEO terminal.

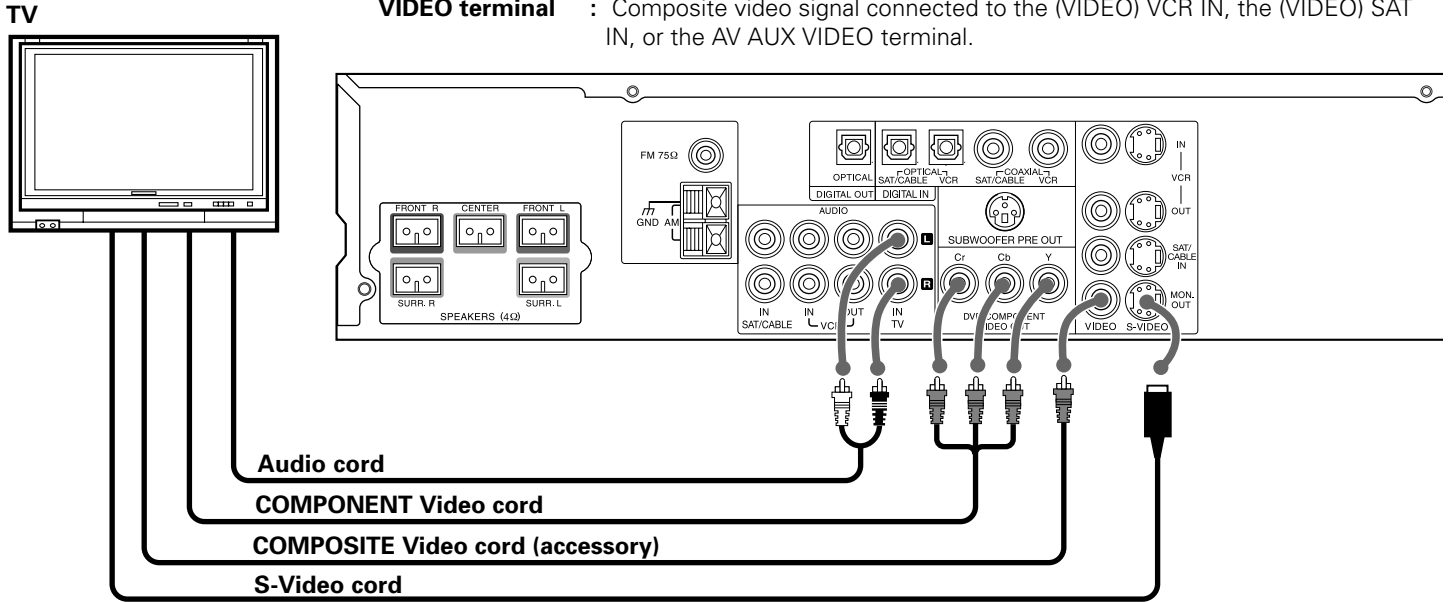

COMPONENT connection corresponds only to some areas.

When the TV has a COMPONENT terminal, the DVD image will be played back with higher picture quality in case of COMPONENT connection. Connect the S-video or the COMPOSITE video cable also in this case.

Connecting to a Satellite Tuner or Cable Tuner

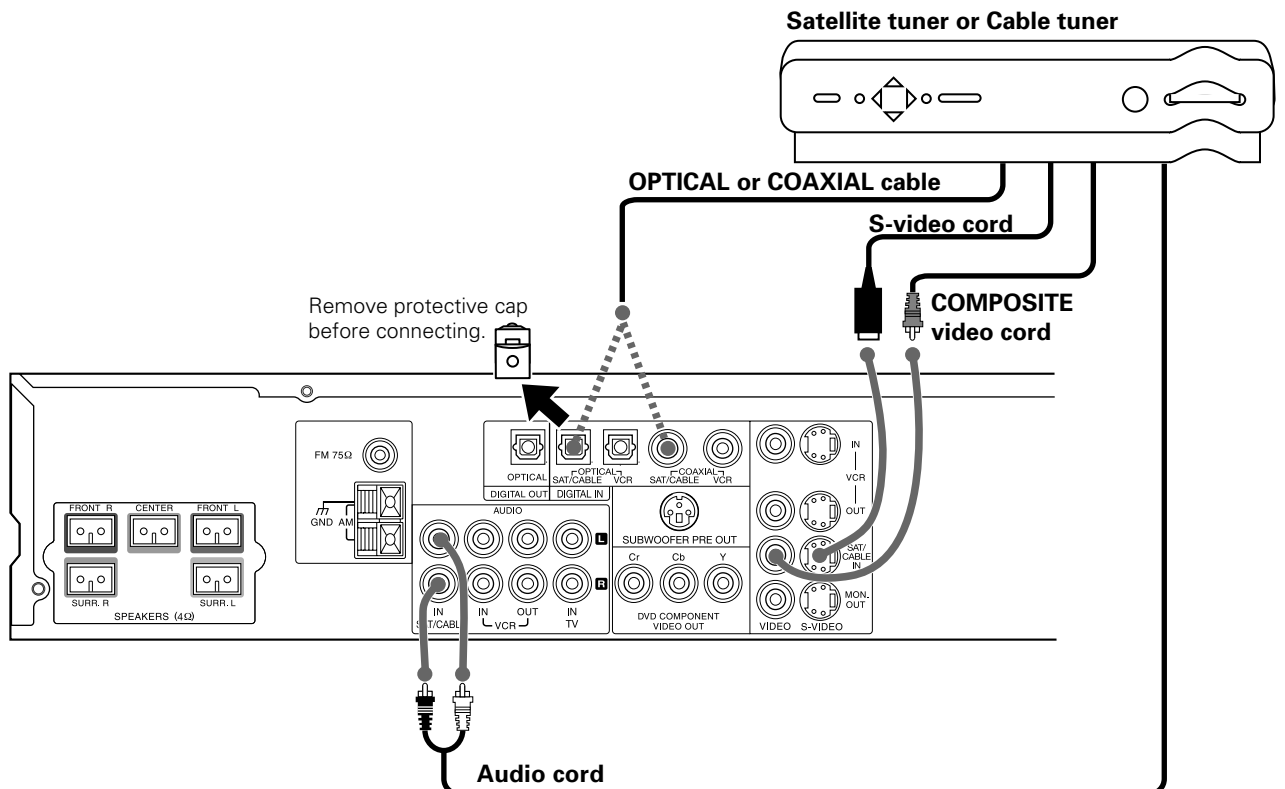

Connect the OPTICAL or the COAXIAL cable, depending on the digital output of the satellite tuner.

Connecting to Audio video (PVR) equipments

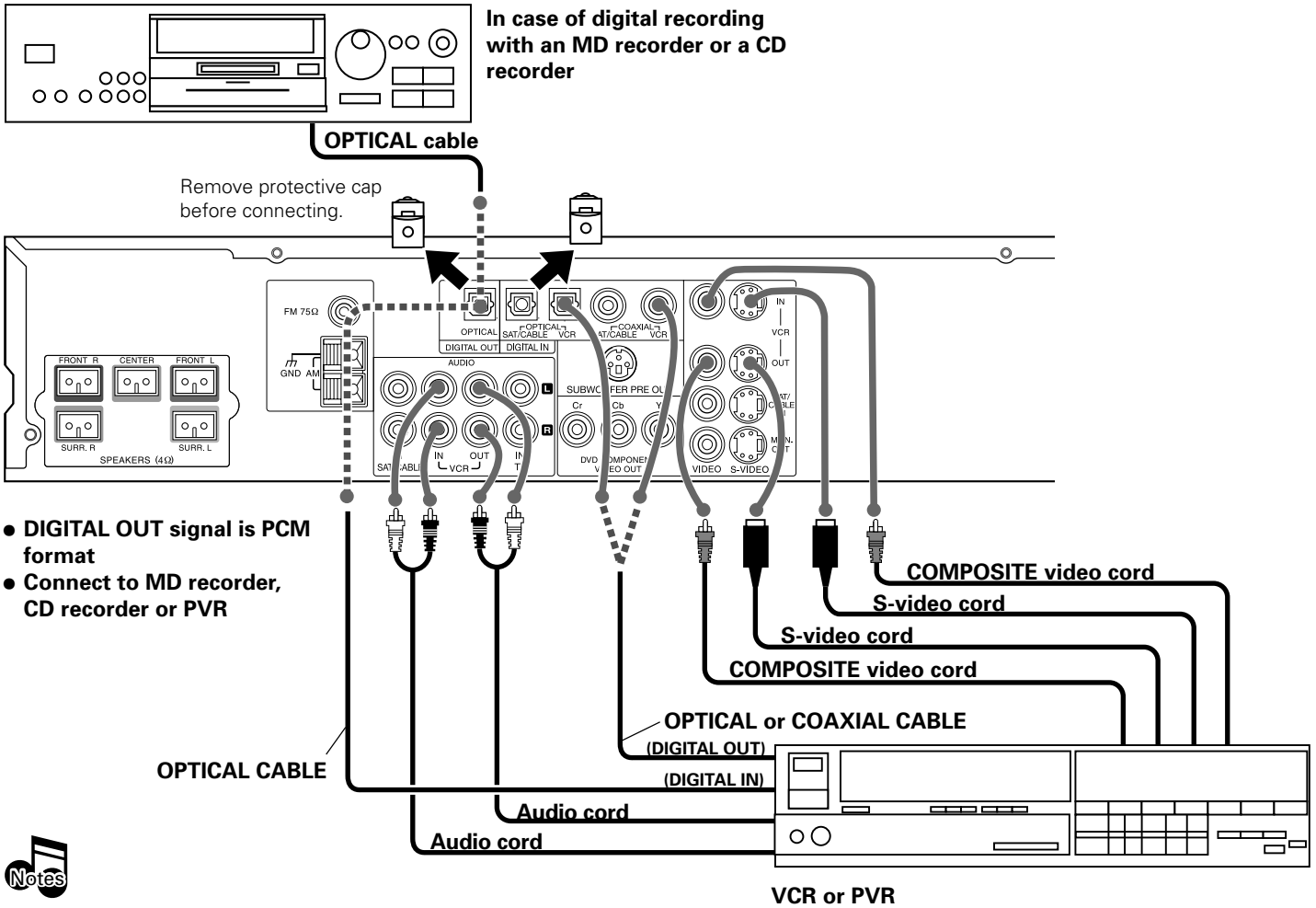

- Analog recording of DTS-encoded discs is not possible.
- When connecting this unit to a VCR, connect either analog VCR IN or digital (COAXIAL/OPTICAL) IN, but not both.

Connecting a Camcorder or Video game machine

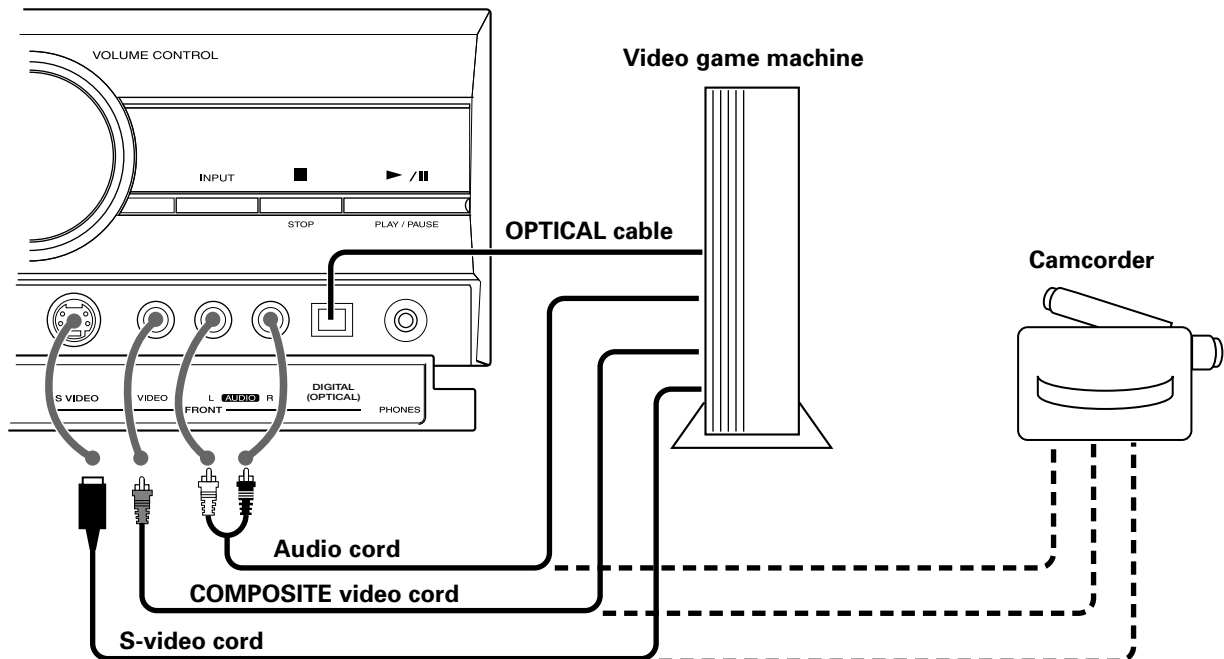

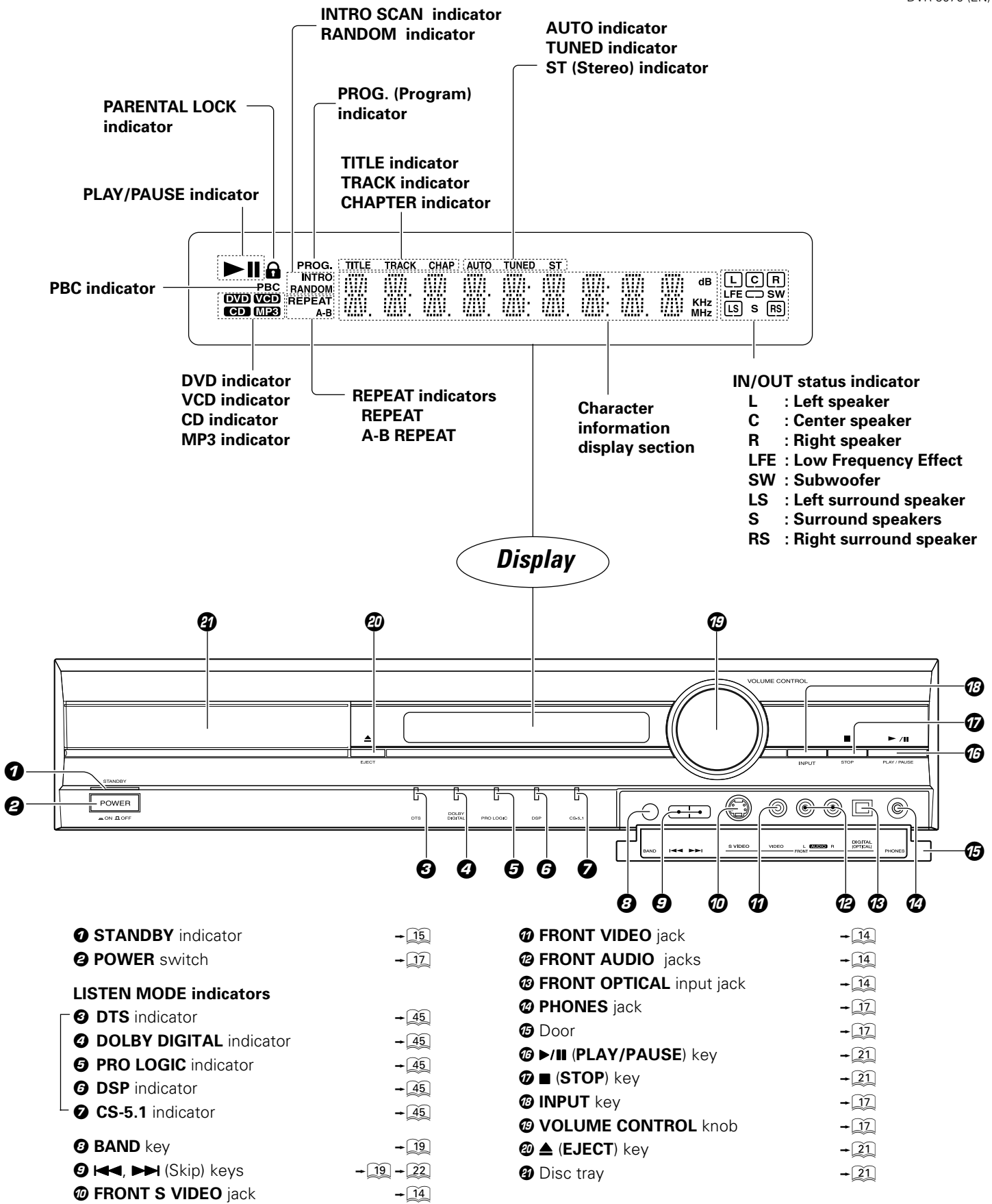

- ① STANDBY indicator → 15
- ② POWER switch → 17
- LISTEN MODE indicators**
- ③ DTS indicator → 45
- ④ DOLBY DIGITAL indicator → 45
- ⑤ PRO LOGIC indicator → 45
- ⑥ DSP indicator → 45
- ⑦ CS-5.1 indicator → 45
- ⑧ BAND key → 19
- ⑨ ◀▶ (Skip) keys → 19 → 22
- ⑩ FRONT S VIDEO jack → 14
- ⑪ FRONT VIDEO jack → 14
- ⑫ FRONT AUDIO jacks → 14
- ⑬ FRONT OPTICAL input jack → 14
- ⑭ PHONES jack → 17
- ⑮ Door → 17
- ⑯ ▶/|| (PLAY/PAUSE) key → 21
- ⑰ ■ (STOP) key → 21
- ⑱ INPUT key → 17
- ⑲ VOLUME CONTROL knob → 17
- ⑳ ▲ (EJECT) key → 21
- ㉑ Disc tray → 21

STANDBY indicator

The **STANDBY** indicator lights when the power cable is plugged into an outlet and the **POWER** switch is set to **ON**. When the **POWER** key on the remote control unit is pressed in **STANDBY** status, the **STANDBY** indicator goes out and the main unit reaches operation status. When the **POWER** switch is set to **OFF** in operation status, the unit will return to operation status when the **POWER** switch is set to **ON** again. When the **POWER** switch is set to **OFF** in **STANDBY** status, the unit will return to **STANDBY** status when the **POWER** switch is set to **ON** again.

16 Operation of remote control unit

DVR-5070 (EN)

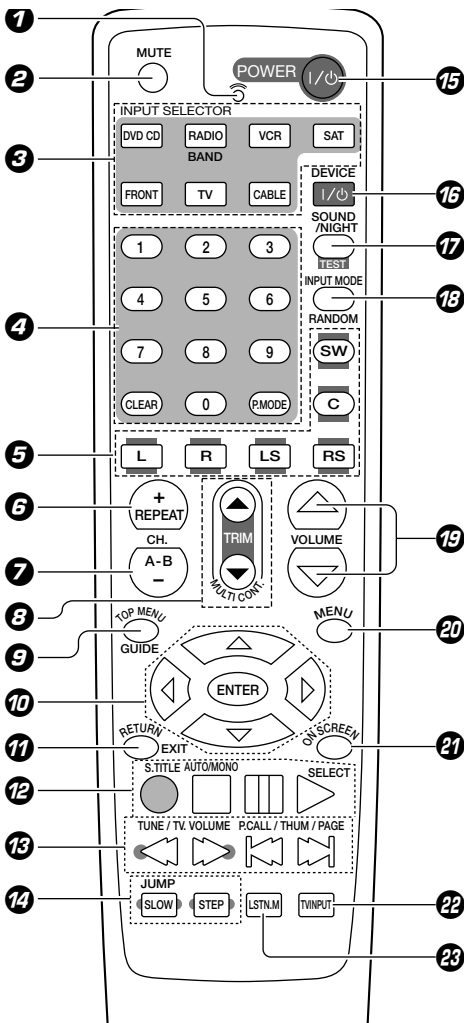

The keys on the remote control unit with the same names as on the main unit have the same function as the keys on the main unit.

- | | | | |
|-----------------------------|------|-----------------------------|-----------|
| ① LED indicator | - 49 | ⑩ RETURN key | - 38 |
| ② MUTE key | - 17 | / EXIT key | - 53 |
| ③ INPUT SELECTOR keys | - 17 | ⑫ ● (record) / | - 53 |
| DVD CD key | | S.TITLE (SUB TITLE) key | - 25 |
| RADIO/BAND key | | ■ (stop) / | - 21 |
| VCR key | | AUTO/MONO key | - 19 |
| SAT (Satellite) key | | ⏸ (pause) key | - 21 |
| FRONT key | | ▶ (play) /SELECT key | - 21 - 53 |
| TV key | | | |
| CABLE key | | ⑬ ◀◀ / ▶▶ key (Search keys) | |
| ④ Numeric keys (0 - 9) | - 22 | TUNE / keys | - 19 - 22 |
| CLEAR key | - 23 | / TV. VOLUME keys | - 53 |
| P.MODE key | - 30 | ◀◀ key / ▶▶ key (Skip keys) | |
| ⑤ Speaker select keys | - 48 | P.CALL keys | - 19 - 22 |
| L (Left front) key | | / THUM / PAGE keys | - 53 |
| R (Right front) key | | ⑭ SLOW / JUMP key | - 22 - 53 |
| LS (Left Surround) key | | STEP key | - 22 |
| RS (Right Surround) key | | ⑮ POWER key | - 17 |
| C (Center) key | | ⑯ DEVICE Power key | - 49 |
| SW (Subwoofer) key | | ⑰ SOUND/NIGHT / TEST key | |
| ⑥ CH.(Channel) + key | - 53 | | |
| /REPEAT key | - 28 | ⑱ INPUT MODE / RANDOM key | - 18 - 47 |
| ⑦ CH.(Channel) - key | - 53 | | |
| /A-B Repeat key | - 28 | ⑲ VOLUME keys | - 17 |
| ⑧ TRIM / MULTI CONT. | | ⑳ MENU key | - 38 |
| Up (▲), Down (▼) keys | - 47 | ㉑ ON SCREEN key | - 23 |
| ⑨ TOP MENU key | - 33 | ㉒ TV INPUT key | - 53 |
| /GUIDE key | - 53 | ㉓ LISTN.M (LISTEN MODE) key | - 18 |
| ⑩ Cursor Up (▲), Down (▼) | - 30 | | |
| Left (◀) and Right (▶) keys | - 23 | | |
| ENTER key | - 23 | | |

Model : RC-R0723
Infrared ray system

Loading batteries

① Remove the cover.

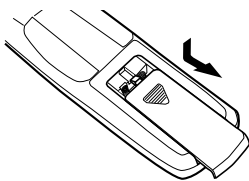

② Insert batteries.

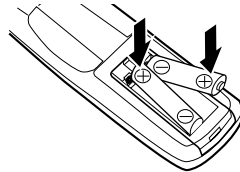

③ Close the cover.

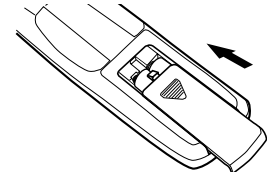

● Insert two LR03 ("AAA"-size) batteries following the polarity indications.

Operation

Insert the power plug into a power outlet, press the POWER switch of the main unit to ON, then press the POWER key on the remote control.

● When pressing more than one remote control keys successively, press the keys securely by leaving an interval of 1 second or more between pressing of keys.

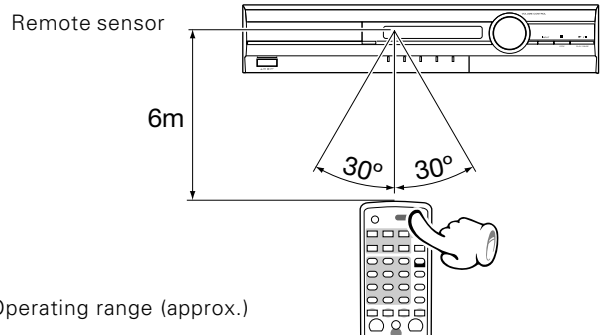

- Notes**
1. The provided batteries are intended for use in operation checking, and their service life may be short.
 2. When the remote controllable distance becomes short, replace both of the batteries with new ones.
 3. If direct sunlight or the light of a high-frequency fluorescent lamp (inverter type, etc.) is incident to the remote sensor, malfunction may occur. In such a case, change the installation position to avoid malfunction.

Preparation



- set the **POWER ON/OFF** switch to the ON () position.

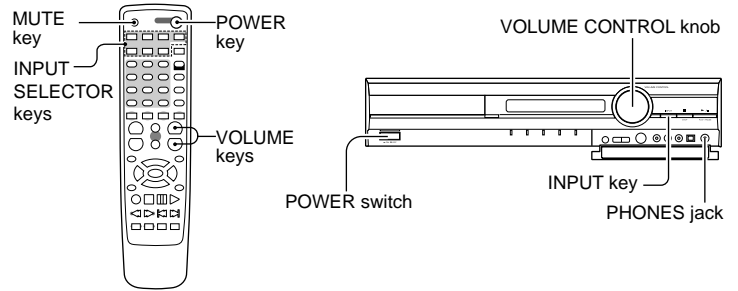

Basic use method

1 Selecting the desired input

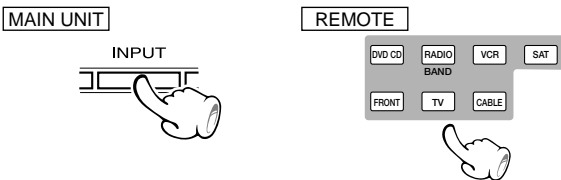

Switching is done as follows when the **INPUT** key of the main unit is pressed.

- ① Tuner (frequency display)
- ② VCR (*VCR →ANALOG→VCR)
- ③ SAT/CABLE (*SAT/CABLE→ANALOG→SAT/CABLE)
- ④ FRONT (*FRONT→ANALOG→FRONT)
- ⑤ DVD/CD
- ⑥ TV

*The indication changes according to the **INPUT MODE** setting.

2 Volume adjustment

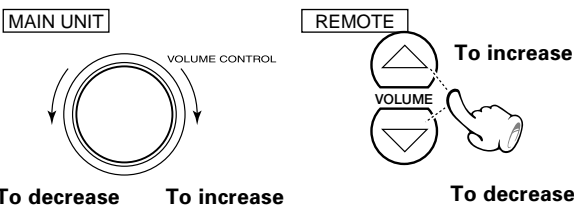

- When one of the keys on the left is pressed while **STANDBY** mode, the power will be switched on automatically and the input will be selected.
- The power will be switched on and the respective operation will be performed also when the **EJECT** key, the **PLAY/PAUSE** key or the **BAND** key on the main unit is pressed during **STANDBY** mode.
- When a disc is set in the disc tray and the **DVD CD** key is pressed, disc playback will start automatically.

In case of operation with the remote control unit, first select the input or device to be operated with the **INPUT SELECTOR keys etc., and then perform the desired operation.**

The present mode of the remote control unit may not coincide with the equipment to be operated.

The input mode can be switched with VCR, SAT/CABLE and FRONT. Refer to "Changing the INPUT MODE"

Normally "80" is displayed when the volume settings set to the maximum value.

Muting the sound temporarily

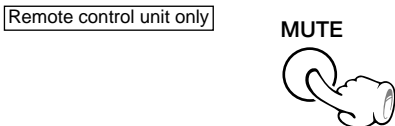

- Press **MUTE** key.
- Press again to resume the original volume.
- The sound muting is also cancelled when the volume is controlled.

Listening through headphone

Insert the headphone plug into the **PHONES** jack.

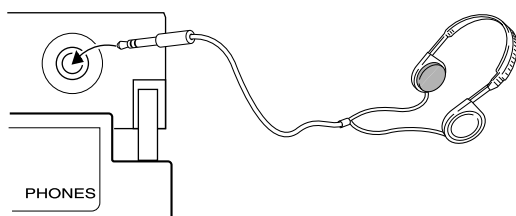

This unit offers various surround modes, but it switches automatically to stereo mode when headphones are connected.

To open the door, pull the lower part on the right side of the main unit.

- **The sounds from all speakers are cut off.**

Selecting the DSP mode

Five different sounds are preset in DSP mode. Please select the type you like.
 DSP mode can be selected only at the time of a PCM source (normal music CD, MP3 file, etc.).

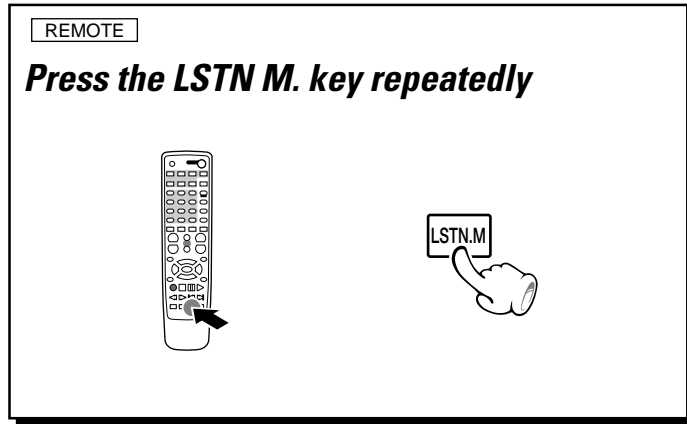

Each press switches the mode
 (At the time of music CD)

- ① DOLBY PL II MOVIE
 - ② DOLBY PL II MUSIC
 - ③ DOLBY PRO LOGIC
 - ④ CIRCLE SURROUND
 - ⑤ ARENA
 - ⑥ JAZZ CLUB
 - ⑦ THEATER
 - ⑧ STADIUM
 - ⑨ DISCO
 - ⑩ STEREO
- DSP modes



Selecting the NIGHT (MID NIGHT) mode. (Dolby Digital only)

Any time you don't want to experience the loud and soft volume extremes of recorded sound (for example, late at night), use NIGHT function to reduce volume extremes.

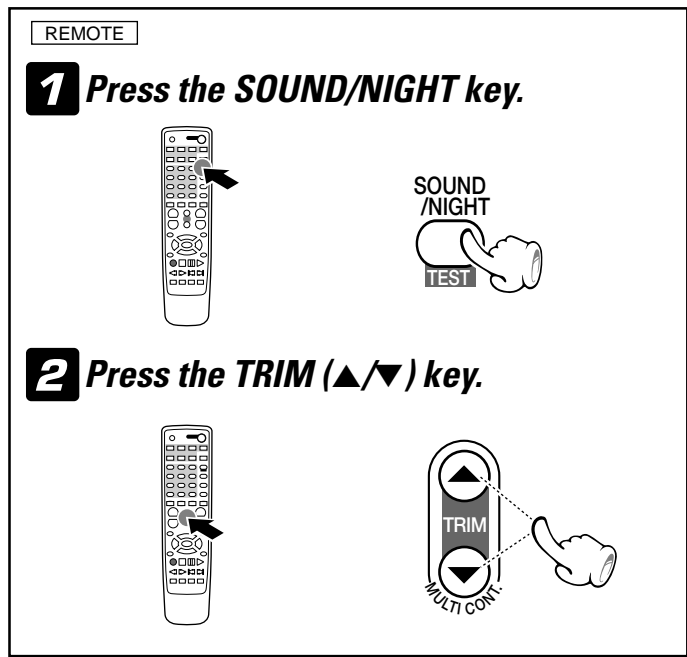

Displayed NIGHT OFF or NIGHT ON.

Each press switches the mode

- ① NIGHT ON
- ② NIGHT OFF

It is also possible to receive them by one-touch operations by storing up to 30 stations in the preset memory. (→ 20)

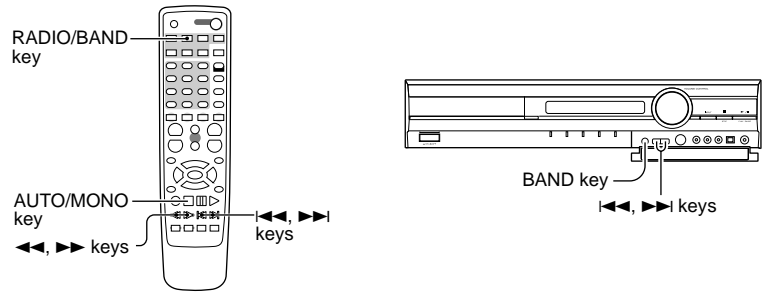

1 Select the TUNER input

MAIN UNIT

REMOTE



BAND

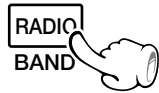

When the BAND key is pressed, this unit will be switched on automatically.

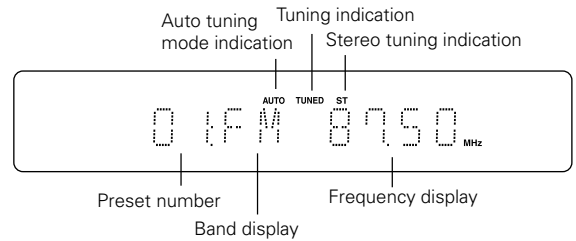

2 Select the broadcast band

MAIN UNIT

REMOTE

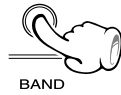

BAND

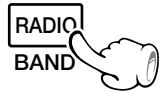

Each press changes the band.

- ① FM
- ② AM

3 Select a tuning mode

REMOTE

AUTO/MONO

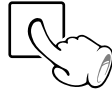

Each press switches the mode

- ① auto tuning mode
- ② manual tuning mode



When the TUNE keys are pressed in AUTO mode, a station will be tuned in automatically and tuning will stop. Stereo reception will be made automatically when a stereo broadcast with sufficient signal strength is received.

4 Select a station

P.CALL (preset call)

MAIN UNIT

REMOTE

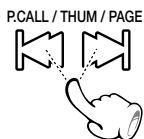
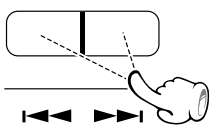

Press the <=> keys to select a preset station.

AUTO (auto tuning)

REMOTE

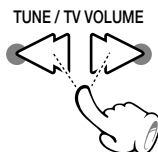

Press the TUNE key to receive the next tuned station automatically

MANUAL (manual tuning)

REMOTE

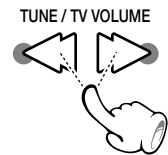

Each time a key is pressed, the frequency is changed by one step. When a key is pressed continuously, the frequency changes continuously. Use the manual tuning mode when reception is noisy due to weak reception. (In the manual mode, stereo broadcasts are received in monaural.)

You can store up to 30 stations in the memory and recall with a single touch of the key.

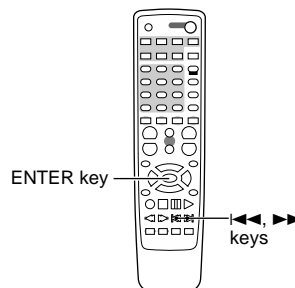

Storing the broadcast stations (one-by-one presetting)

1 Select a station (auto tuning or manual tuning) → 19

2 Press the ENTER key

REMOTE



3 Select the desired preset number

REMOTE

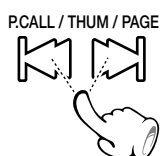

4 Press the ENTER key

REMOTE



Repeat steps **1** to **4** to preset other stations.

Presetting can be done with mixing of FM and AM stations.
(Example)

01: FM 90.00
02: AM 630
03: FM 88.00

Blinks

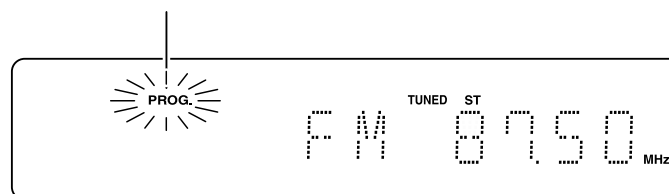

Please perform the next operation while the indicator is blinking.

In case of input with the number keys, a preset number will be decided simply by input of a 2-digit number without pressing the ENTER key.

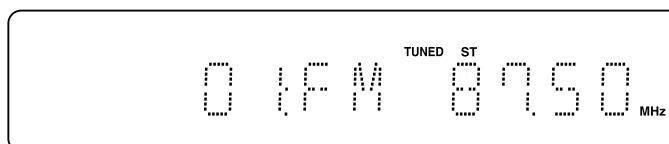
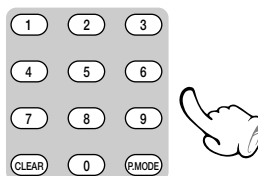
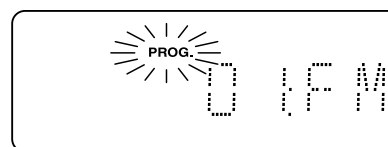

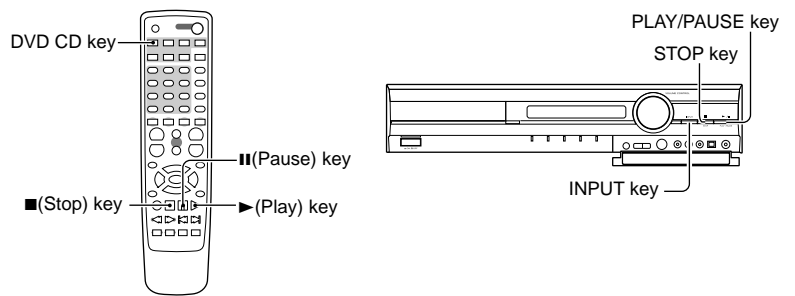

Basic play

1 Load a disc

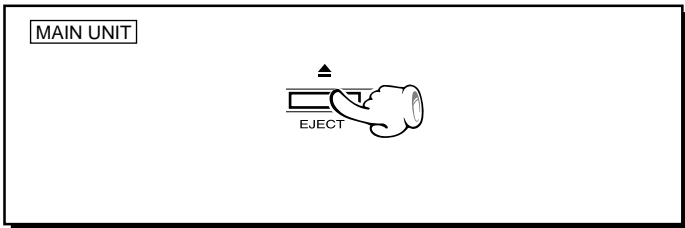

- 1 Open the tray.
- 2 Place a disc.
- 3 Close the tray.

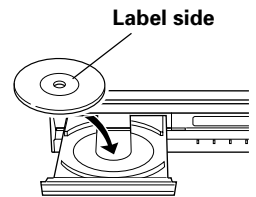

- When the **PLAY/PAUSE** key on the main unit is pressed instead of the **EJECT** key in step 3, the tray will close and playback will start automatically.

2 Select the DVD CD

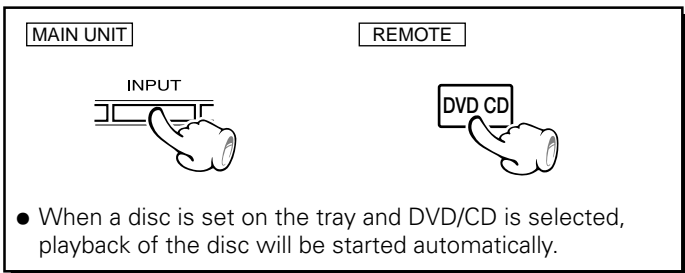

When a Disc Menu appears on the screen

In case of interactive DVDs, a Disc Menu appears on the screen. Then press **ENTER** to select specific menu you want to play by using Cursor keys.

- When a disc is set on the tray and DVD/CD is selected, playback of the disc will be started automatically.

When a menu screen is recorded on the disc, the menu screen will be displayed when the TOP MENU key is pressed. At the menu screen, the menu can be selected by pressing the Cursor keys.



3 Start playback

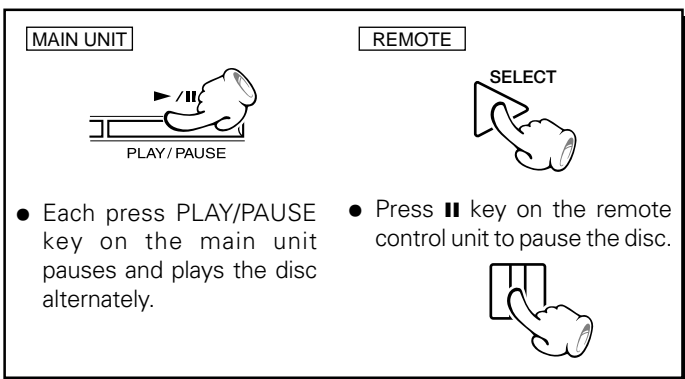

- When the **PLAY/PAUSE** key on the main unit is pressed while an input other than disc is selected, the unit will be switched to DVD/CD and playback will start.

- Each press **PLAY/PAUSE** key on the main unit pauses and plays the disc alternately.
- Press **||** key on the remote control unit to pause the disc.

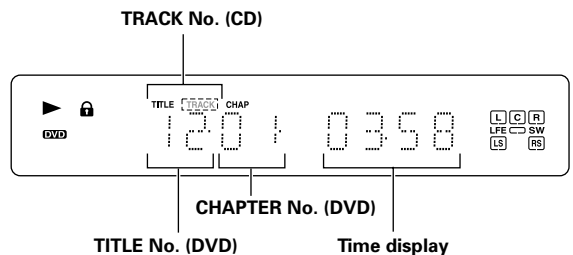

To stop playback

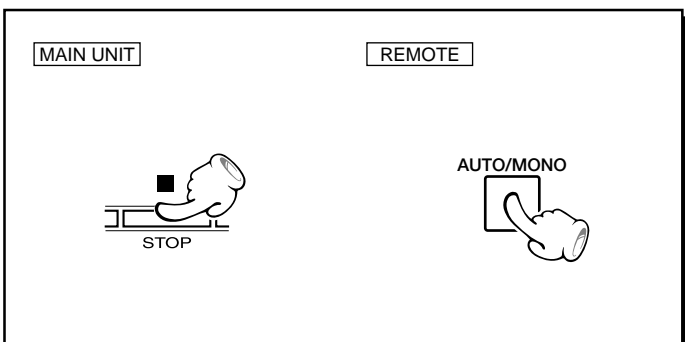

RESUME playback

When the **STOP** key has been pressed once during playback to stop the playback, and then playback is started again, play will start from the point where the playback had been stopped. This is called the **RESUME** function. When the **STOP** key is pressed again during stop, the **RESUME** function is cancelled.

RESUME is cancelled when 5 minutes have passed in **RESUME** status.

Disc playback features



- You won't hear the sound (audio) on the DVD when you're using the Skip, Search, Step or Slow motion features.
- Playback features are not available during the opening credits of a movie.

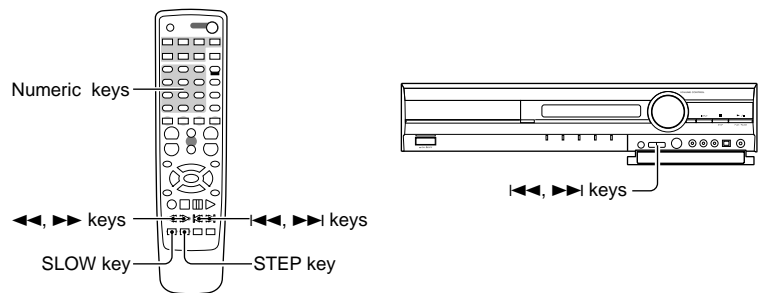

DVD CD VCD Skipping chapters or tracks

MAIN UNIT

To skip backward To skip forward

REMOTE

To skip backward To skip forward

- The chapter (or track) in the direction of the key pressed is skipped, and the selected chapter (or track) will be played from the beginning.
- When the <<< key is pressed once during playback, the chapter (or track) being played will be played from the beginning.

DVD CD VCD Searching

REMOTE

To search backward TUNE / TV VOLUME To search forward

- During playback, press the <<< or >>> key
- Each press switches the searching speed.
 - ① × 2 (F.SEARCH 1)/(R.SEARCH 1)
 - ② × 4 (F.SEARCH 2)/(R.SEARCH 2)
 - ③ × 8 (F.SEARCH 3)/(R.SEARCH 3)
 - ④ × 16 (F.SEARCH 4)/(R.SEARCH 4)
 (At the time of DVD playback only)
- Press the **PLAY** key at any time to resume normal playback.
- **Audio is not output during F.SEARCH or R.SEARCH playback.**

CD Playback from desired track

REMOTE

- Select the desired track No.
- Press the numeric keys as shown below (Example)
To select track No. 23 : **2 3**
- When a number exceeding the largest track No. on the CD being played is specified, a question mark "Tr ?" will be displayed.

DVD VCD STEP (freeze frame and frame advance)

REMOTE

STEP

- Each time you press the <<<, >>> keys, the picture advances one frame.
- At the time of VCD playback, backward STEP is not possible.
- Press the **PLAY** key to resume normal playback.

DVD VCD Slow motion playback

REMOTE

JUMP SLOW

- During playback, press the **SLOW** keys, then press the <<<, >>> keys.
- Each press <<<, >>> keys switches the motion speed.

(At the time of DVD playback)

- ① F.SLOW 1/16 (R.SLOW 1/16)
- ② F.SLOW 1/8 (R.SLOW 1/8)
- ③ F.SLOW 1/4 (R.SLOW 1/4)
- ④ F.SLOW 1/2 (R.SLOW 1/2)

(At the time of VCD playback)

- ① F.SLOW 1/8 (R.SLOW is not possible)
- ② F.SLOW 1/4 (R.SLOW is not possible)
- ③ F.SLOW 1/2 (R.SLOW is not possible)

- Press the **PLAY** key to resume normal playback.

The on-screen Banner Display contains many playback features. To see the Banner Display, press ON SCREEN key on the remote while a disc is playing. Use the Cursor (Up/Down/Left/Right) keys on the remote to move through the different features in the Banner Display. Each feature is illustrated with an icon.

1 During playback, press the ON SCREEN key on the remote.



2 Press the Cursor left/right (</>) keys to highlight a banner display icon.

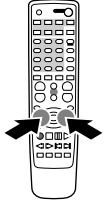

3 Press the ENTER key.

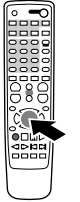

When playing a DVD

TITLE	CHAPTER	AUDIO	SUBTITLES	ANGLES	BOOKMARKS	DISC TYPE
T 1	C 21	1: ENG	1: ENG	Ang. 1	Mark	0:30:00

TIME INDICATOR

When playing a CD/VCD

TRACK	INTROSCAN	BOOKMARKS	TIME INFORMATION	DISC TYPE
Tr. 1	IntroScan	Mark	Time	0:30:00

Time indicator contents

TIME INDICATOR

Switch the CD time indicator as follows.

- 1** Select the time information with the cursor key.
- 2** Each time the ENTER key is pressed, the time indicator changes as follows.
 - 1** Track Elapsed (elapsed time of the track being played)
 - 2** Track Remain (remaining time of the track being played)
 - 3** Disc Elapsed (elapsed time of the disc being played)
 - 4** Disc Remain (remaining time of the disc being played)

To display disappear from the screen

Press the ON SCREEN key or CLEAR key

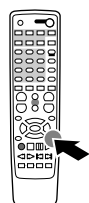

or

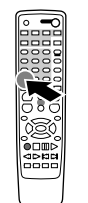

ON SCREEN

CLEAR



- You can only access the banner display when you're playing a disc.
- The banner display feature are only available if the disc was created with that particular feature (i.e., if you select the Subtitle icon, you won't be able to change the subtitle language unless the author of the disc created the disc with subtitles).
- The invalid symbol  appears on the screen when you press a key that doesn't have any function. If one of the icons is "grayed out," the banner display feature isn't available for the disc you're playing.

DVD Selecting a Title

Some discs contain more than one title. For example, there might be four movies on one disc (each movie might be considered a title).

- ① During playback, press the ON SCREEN key on the remote.



- ② Press the Cursor left/right (◀/▶) keys until the TITLE icon is highlighted.

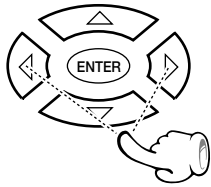
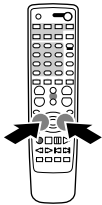

- ③ Press the ENTER key. ("T_" appears)

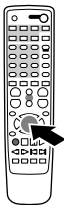

- ④ Use the numeric keys to enter the title number.

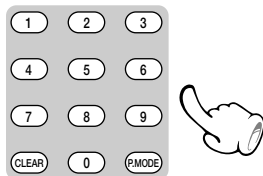

When you enter a one-digit Title number, you may have to press ENTER on the remote after pressing the numeric key (1~9) on the remote. Otherwise press 0 first and the other value. Then play starts. This varies depending on number of Title within the disc you're playing.



Some discs only have one title.

DVD CD VCD Selecting a Chapter or Track

Because DVD discs use digital technology, a title can be divided into individual chapters (similar to tracks on a CD). You can skip a specific chapter by using the Chapter section in the Banner Display.

- ① During playback, press the ON SCREEN key on the remote.



- ② Press the Cursor left/right (◀/▶) keys until the CHAPTER or TRACK icon is highlighted.

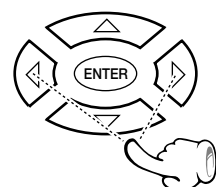
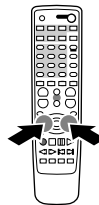

- ③ Press the ENTER key. ("C_" or "Tr_" appears)

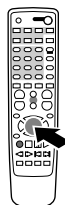

- ④ Use the numeric keys to enter the chapter or track number.

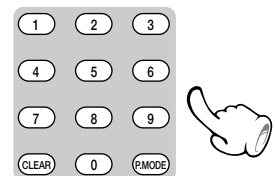

When you enter a one-digit chapter or track number, you may have to press ENTER on the remote after pressing the numeric key (1~9) on the remote. Otherwise press 0 first and the other value. Then play starts. This varies depending on number of chapter or track within the disc you're playing.





- The Chapter feature won't work if the disc isn't formatted with separate chapters.
- P.B.C. on mode of VCD, the Selecting a Track function may not work.

DVD Changing the Audio Language

If the disc was created with different language tracks, you can use the Banner Display to temporarily change the DVD player's Audio setting.

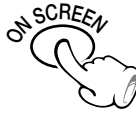
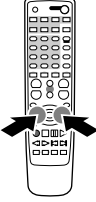
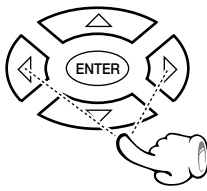
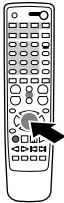
Using the on-screen banner display

- 1 During playback, press the ON SCREEN key on the remote.
 

- 2 Press the Cursor left/right (◀/▶) keys until the AUDIO icon is highlighted.
 

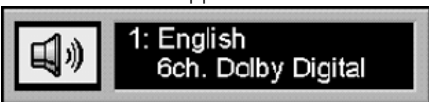
- 3 Press the ENTER key.
 

The audio menu appears



- 4 Select the audio language with press the ENTER key.
 

- The menu is switched off when no operation is performed for about 5 seconds.







1. The language feature only works if the disc was created with multiple audio tracks.
2. When you chose an audio language from the Banner Display, you only override the audio language setting in the DVD Player's main menu (in the Language Preferences menu within Setup menu) temporarily.

DVD Changing the Subtitle Language

You can change the Subtitle language while you're watching a disc (but only if the disc was created with subtitles).

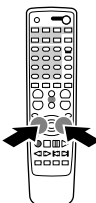
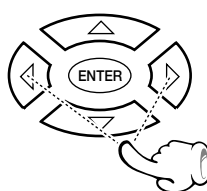

Using the on-screen banner display

- 1 During playback, press the ON SCREEN key on the remote.
 

- 2 Press the Cursor left/right (◀/▶) keys until the SUBTITLE icon is highlighted.
 

- 3 Press the ENTER key.
 

The subtitle menu appears



Displayed when SUBTITLE is ON

- 4 Select the subtitle language with press the ENTER key.
 
- 5 Press the S.TITLE key to subtitle ON or OFF.
 

- The menu is switched off when no operation is performed for about 5 seconds.







1. The subtitle feature only works if the disc was created with multiple subtitle tracks.
2. The subtitle menu of the disc appears in some discs.

DVD Changing the Camera angle

Some disc contains multiple angles particular scene or sequence. If the disc only has one angle, this feature won't work.

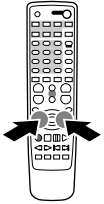
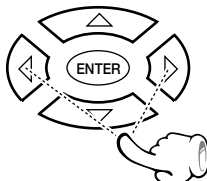
Using the on-screen banner display

- 1 During playback, press the ON SCREEN key on the remote.
 

- 2 Press the Cursor left/right (◀/▶) keys until the ANGLE icon is highlighted.
 

- 3 Press the ENTER key.
 

The ANGLE menu appears







- 4 Select the angle with press the ENTER key.

- The menu is switched off when no operation is performed for about 5 seconds.

CD VCD Using IntroScan function

IntroScan plays the first few seconds of each track on only one disc similar to the scan feature that's on many car radios.

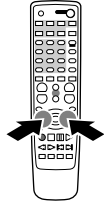
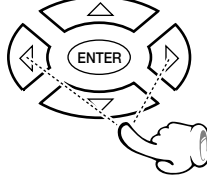
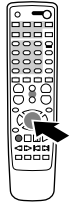
Using the on-screen banner display

- 1 During playback, press the ON SCREEN key on the remote.
 

- 2 Press the Cursor left/right (◀/▶) keys until the IntroScan icon is highlighted.
 

- 3 Press the ENTER key.
 

- The first 10 seconds of each track play.
- After Intro Scan goes through all of the tracks, it stops.
- If you want to stop IntroScan while it's in progress, just press ENTER key on the remote (the current track starts playing in its entirety).

(When the On-screen display has gone out, press the ON SCREEN key, select Intro Scan, and press the ENTER key.)



P.B.C. on mode of VCD, the IntroScan function may not work.

DVD CD VCD Using Bookmarks

The bookmark feature lets you mark a point on the disc that you can go to quickly. You can store up to 9 bookmarks.

Create the bookmark

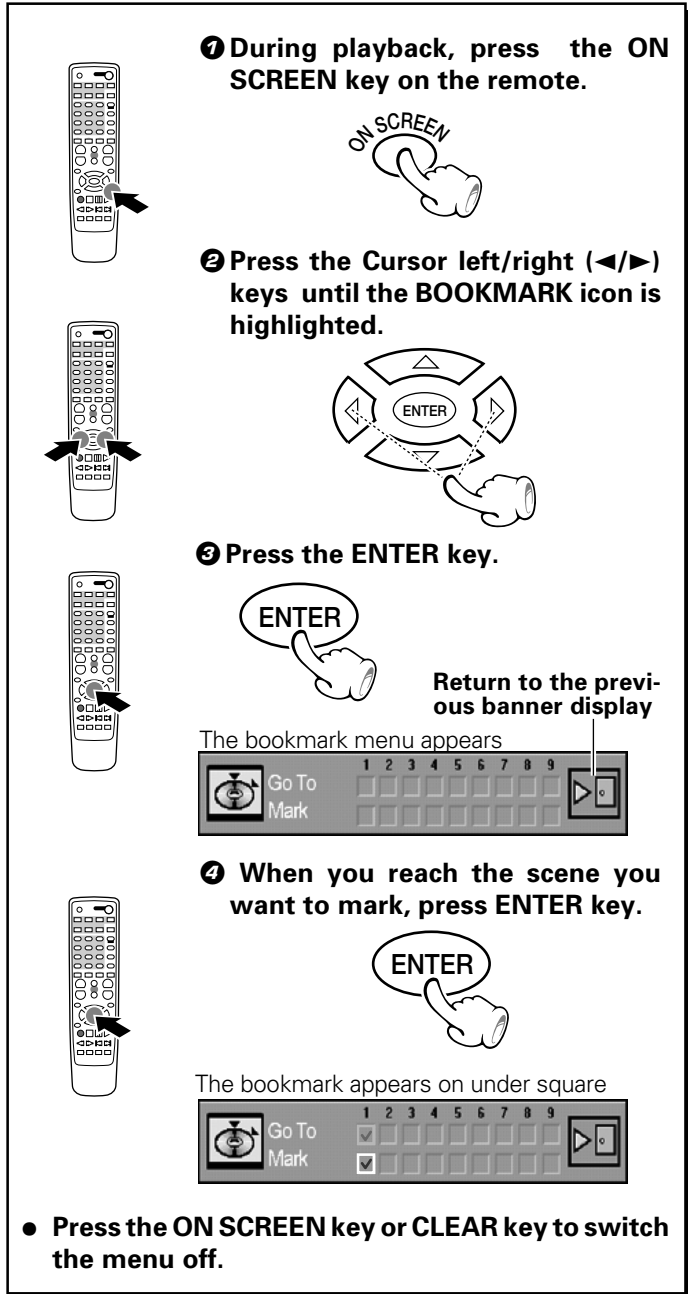

- During playback, press the ON SCREEN key on the remote.
- Press the Cursor left/right (◀/▶) keys until the BOOKMARK icon is highlighted.
- Press the ENTER key.
- When you reach the scene you want to mark, press ENTER key.

The bookmark menu appears

The bookmark appears on under square

- Press the ON SCREEN key or CLEAR key to switch the menu off.

Clearing a bookmark

- The bookmark is cleared each time the disc changes or when the power is turned off.



- If all 9 bookmarks are in use, you can still mark new scenes, but the previous bookmarks will be erased.
- Depending on the disc, the Bookmark function may not work
- P.B.C. on mode of VCD, the Bookmark function may not work.

Recalling a bookmarked scene

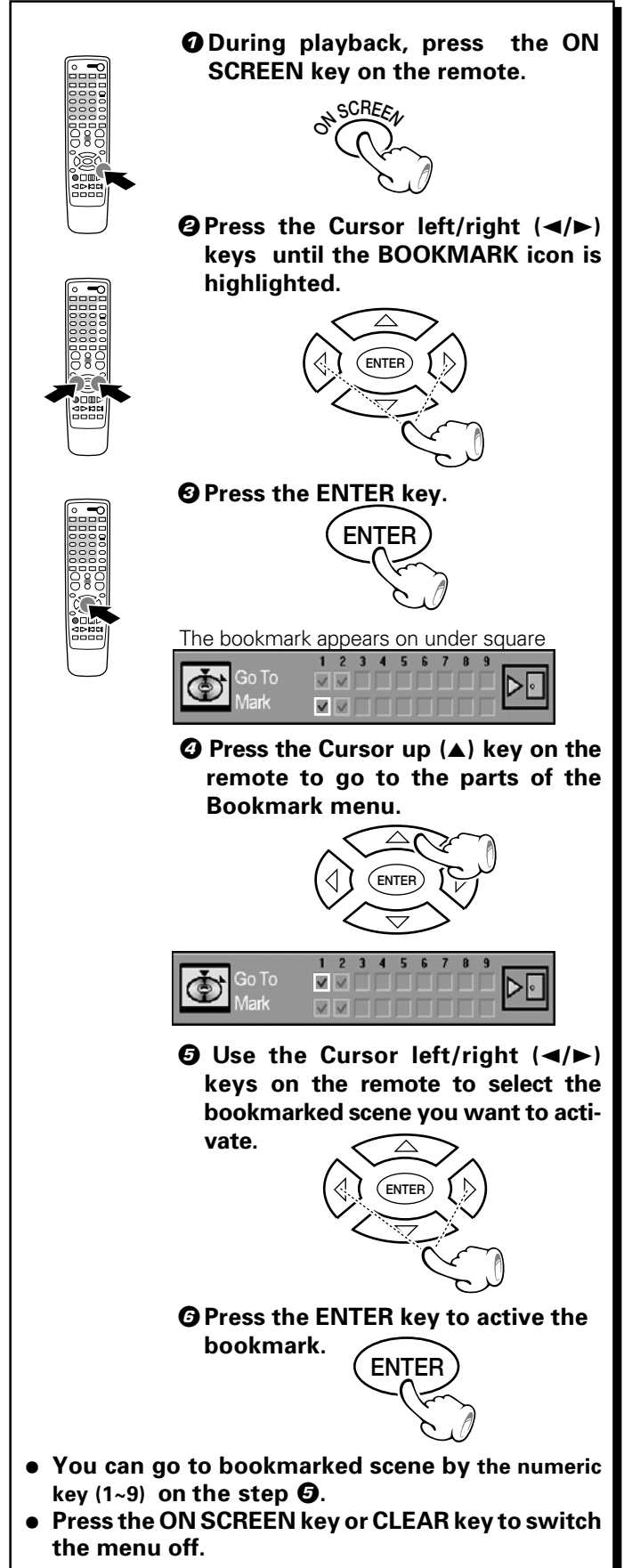

- During playback, press the ON SCREEN key on the remote.
- Press the Cursor left/right (◀/▶) keys until the BOOKMARK icon is highlighted.
- Press the ENTER key.
- Press the Cursor up (▲) key on the remote to go to the parts of the Bookmark menu.
- Use the Cursor left/right (◀/▶) keys on the remote to select the bookmarked scene you want to activate.
- Press the ENTER key to active the bookmark.

The bookmark appears on under square



- You can go to bookmarked scene by the numeric key (1-9) on the step ⑤.
- Press the ON SCREEN key or CLEAR key to switch the menu off.

DVD CD VCD Repeat play



Desired titles or discs can be played back repeatedly.

- Repeat Disc – Repeat the disc that is playing.
- Repeat Title – Repeat the title that is playing.
- Repeat Chapter – Repeat the chapter that is playing.
- Repeat Track – Repeat the track that is playing.

During playback, press REPEAT on the remote.

The Repeat display appears

Each press the key switches the REPEAT mode.

When the REPEAT key is pressed, the following display is shown on the TV screen.

At the time of DVD playback

- ➔ ① Repeat Disc
- ➔ ② Repeat Title
- ➔ ③ Repeat Chapter
- ➔ ④ Repeat Off

At the time of CD/VCD playback

- ➔ ① Repeat Disc
- ➔ ② Repeat Track
- ➔ ③ Repeat Off

At the time of REPEAT mode "REPEAT" is lit.

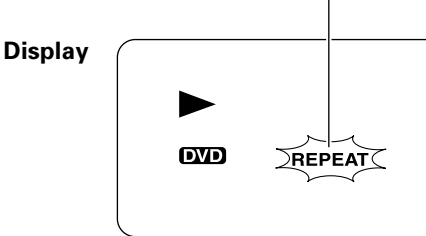

- To cancel repeat playback, press the REPEAT key and select "Repeat off".
- The menu is switched off when no operation is performed for about 5 seconds.

DVD CD VCD A-B Repeat play

The A-B repeat function lets you mark a segment to repeat between the beginning "A" and the end "B" of the segment you want to replay.

➊ Press the A-B key on the remote when you want to choose a scene (sound) as the beginning point.

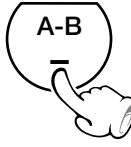
The Repeat A- display appears

➋ Press the A-B key again to choose a scene (sound) as the end point.

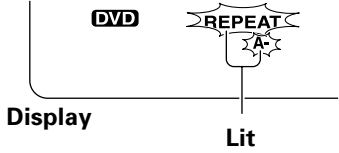
The Repeat A-B display appears

- To cancel A-B Repeat playback, press the A-B key and select "Repeat off".
- The menu is switched off when no operation is performed for about 5 seconds.

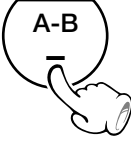

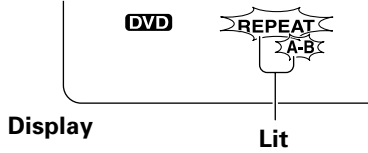
- P.B.C. on mode of VCD, the Repeat play function may not work



- P.B.C. on mode of VCD, the A-B Repeat play function may not work.

CD VCD **Random play**

The tracks of disc are played in random order.

During playback or stop mode, press RANDOM key on the remote.



INPUT MODE
RANDOM

Lit

Display

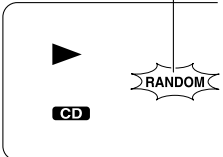

The Random Play display appears



Each time you press RANDOM key on the remote, random play would be on and off.

① "Random Play"
② "Standard Play"

The Standard Play display appears when random is off.



- The menu is switched off when no operation is performed for about 5 seconds.

- When the **RANDOM** key is pressed during playback, the tracks of the disc being played will be selected in random order for playback.
- After all tracks of a disc have been played in random order, playback will stop. (Random mode will be cancelled.)



- When playing a DVD, the Random function may not work.
- P.B.C. on mode of VCD, the Random play function may not work.



You can listen to the desired tracks or chapters of the current disc in any desired order.

Registering and playing the program

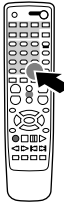

Insert the disc to be used in programming in the tray, close it and press the PLAY key so that the player reads the disc information by playing disc until display "READING" disappears. (If the tray is opened after this, the above procedure should be repeated so that the player reads disc information again.)

Program Edit

- ➊ During stop mode, press the P.MODE key on the remote.

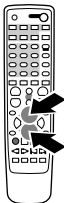
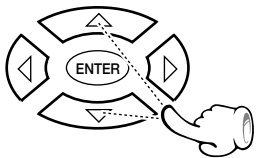

- ➋ Select specific title/chapter or track by Press Cursor up/down (▲/▼) keys or numeric keys (0-9).

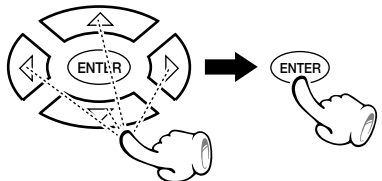

- ➌ Press the ENTER key.



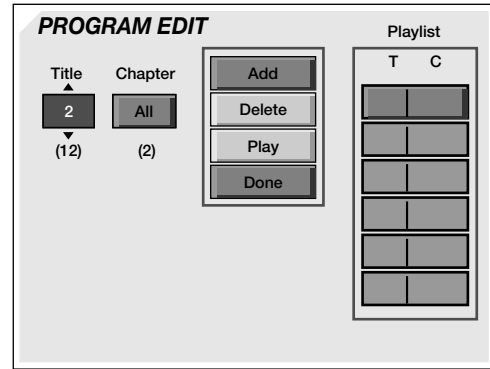

- ➍ Select Add icon on the screen to register selected value onto Playlist, then press the ENTER key.



- ➎ You can select maximum 32 values by repeating step ➋ - ➍.
- ➏ Press the PLAY key to start playback.

Program edit display appears.

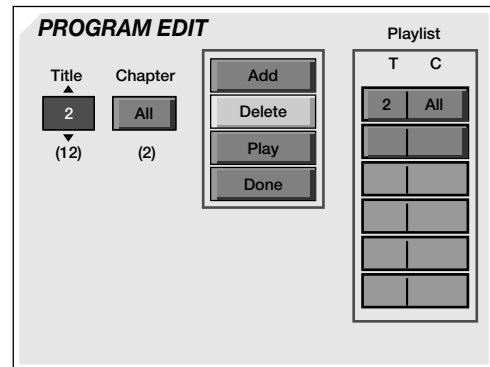

(An example of DVD program edit menu)

-  : Selected icon
-  : An icon which can be selected
-  : An icon which presently can not be selected



- When you don't add values onto "Playlist" and return to play mode, select Done icon and press ENTER key on the remote.
- While a disc is playing, press P.MODE key on the remote to start Program play
- To return to standard play, press the P.MODE key again.
- MP3 discs can not be programmed with this program mode. (MP3 program play -- 37)



- Add icon --- Add value onto "Playlist"
- Delete icon --- Delete value from "Playlist"
- Insert icon --- Insert value in "Playlist"
- Play icon --- Play program play
- Done icon --- Return to stop or resume mode

Insert chapter or track

During stop mode, press the P.MODE key on the remote



1 Select specific title/chapter or track to insert by Press Cursor up/down (▲/▼) keys or numeric keys (0-9).

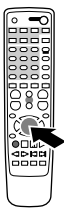

2 Move the cursor with the Cursor right (▶) key to the "Playlist" and select the column to be added with the Cursor up/down (▲/▼) keys.

(The color of the column where the Cursor is located will change.)



3 Move the cursor with the Cursor left (◀) key to the Insert icon and press the ENTER key.

The new chapter or track will be inserted before (above) the selected column.

PROGRAM EDIT

Title	Chapter	Insert Delete Play Done	Playlist	
2	All		T	C
(12)	(2)		2	All
			3	12
			1	8
			1	All
			3	5

(An example of DVD program edit menu)

PROGRAM EDIT

Title	Chapter	Insert Delete Play Done	Playlist	
2	All		T	C
(12)	(2)		2	All
			3	12
			2	All
			1	All
			3	5

Delete Program

During stop mode, press the P.MODE key on the remote

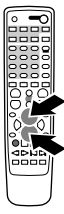

1 Use the Cursor up/down (▲/▼) keys to select the column to be deleted from the "Playlist". (The color of the column where the Cursor is located will change.)



2 Press the Cursor left (◀) key, use the Cursor up/down keys to move the Cursor to the Delete icon, and press the ENTER key. Or press the clear key.

Selected value deletes

PROGRAM EDIT

Title	Chapter	Add Delete Play Done	Playlist	
2	All		T	C
(12)	(2)		2	All
			3	12
			1	8
			1	All
			3	5

Release Program play

In following case, Program play would be released.

1. When you open and close tray.
2. When you turn power off and on.



P.B.C. on mode of VCD, the Program play function may not work.

VCD Hierarchical structure of VCD menus

When an item is selected on the menu screen during playback of a P.B.C.-compatible VCD, another menu with more details items may be displayed. When a number of menus are connected in multiple layers in this way, it is said that the menus have a hierarchical structure. In this structure, the desired scene can be reached by repeating item selections on the menu screens.

Example for a hierarchical structure

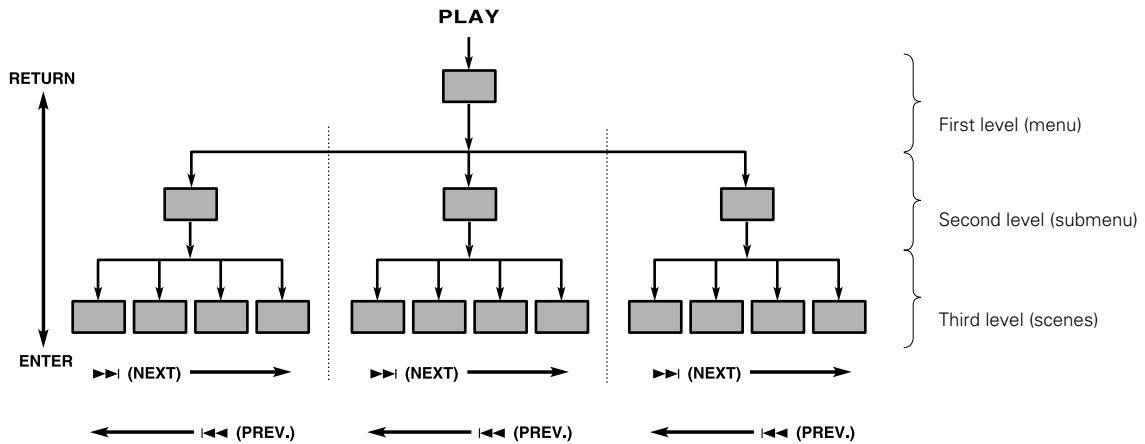

Advancing

When an item is selected on the menu screen with the ► key or the numeric keys, advance is made to the next lower menu level. When the advance destination is the “scene” to be played, the contents will be played.

Returning

Each time the RETURN key is pressed, return is made to the next higher menu.

- When several menus (scenes) can be selected in each level, screen switching is possible with the keys ►► (NEXT) and ◀◀ (PREV.).

Examples of operation keys and indications used during VCD playback

Soft jacket indication	▶	◀	◀◀	▶▶	ENTER or SELECT
KENWOOD operation key	▷	RETURN	◀◀	▶▶	ENTER

- Depending on the software, the jacket indication may differ from the above.

VCD Playback without using the menu playback function (In case of a P.B.C.-compatible VCD) (To P.B.C. On or Off)

Press the TOP MENU key on the remote control unit.



- For the track numbers, refer to the disc jacket or other material.
- P.B.C. off mode : Without using menu playback function.

P.B.C. off mode

Goes off

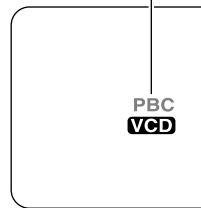

To return to menu playback

Press the TOP MENU key again.

P.B.C. on mode

Lit

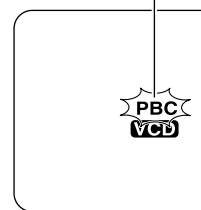

Guidance of MP3

Media that can be played back with this equipment

Usable media : CD-ROM, CD-R, CD-RW

Usable format : ISO9660 level 1.

Files that can be played back : MP3 files

Creating media for playing back on this equipment

Compressing MP3

Please set up the transfer bit rate setting for the compression software when compressing MP3 files as follow.

MP3 Files : 128kbps recommended (32kbps-320kbps)

- **This unit is compatible with 32 kHz, 44.1 kHz (recommended) and 48 kHz sampling frequencies.**

Naming folders and files

Single-byte characters between A and Z, single-byte numerals between 0 and 9, and the single-byte underscore(_) can be displayed. Ensure that the ".MP3"(MP3 files) extension log is attached to all file names.

- **Never add the MP3 extension log to any files other than MP3 files. If the MP3 extension log is added to any files other than MP3 files, the equipment will assume that they can be played back, and this will produce loud noises in the speakers, resulting in damage of adverse effects.**

Confirming media and files

Check to ascertain that MP3 files can be played back correctly on the personal computer in use prior to saving them onto the media. Check to ensure that the saved file can be played back normally.

- **It is not possible to confirm that files can be played back correctly while they are being saved onto the media.**

When saving files onto media

Ensure that the session is closed or finalized when data has been written on media. There are cases where media on which the session has not be closed or finalized will not be played back correctly with this equipment.

- **There are cases where the folder names and file names will not be displayed correctly depending on the software used to save them.**
- **Do not store files or folders other than MP3 on media to be played back with this equipment.**
- **It is recommended that ten or less sessions are stored when recording MP3 files onto a media.**
- **Some time may be required until the playback of multi-session discs starts.**
- **There are cases where playback is not possible when MP3 files (CD-ROM) and music CD information (CD-DA) are saved on the same media.**

Example for a hierarchical structure

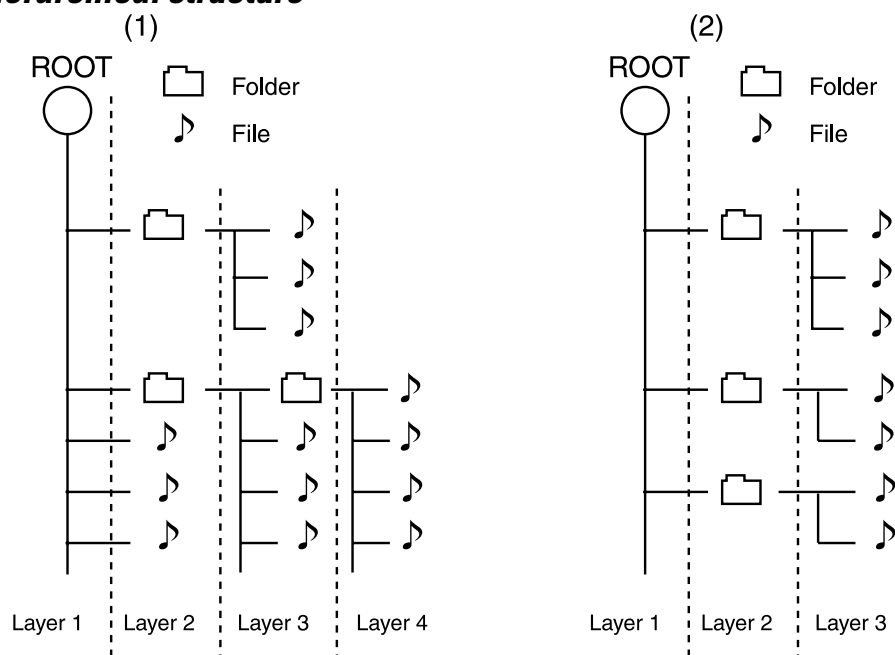

MP3 On-screen display

When you insert MP3 media, the MP3 On-screen display appears.

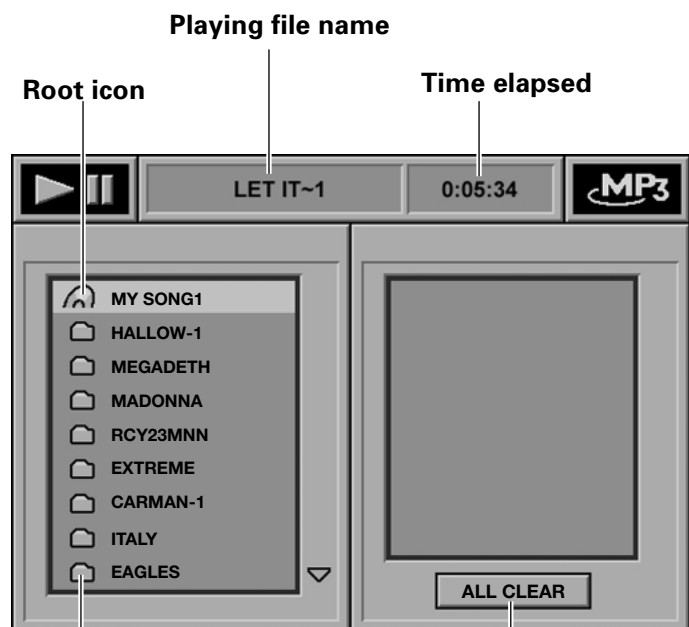

Folder icon

Return folder icon



Files

Program window



Folder names and file names are displayed up to 8 characters. When folder names and file names are recorded with more than 8 characters, the names will be displayed in abbreviated form.

Playing back MP3

- It is not possible to play back folders and files (up to 223) that exceed the maximum limitations of the media.
- A certain amount of time is required for the player to confirm the media on which MP3 files have been recorded before playback will commence.
- The files will be played back in the sequence in which they were recorded (written).

Playback

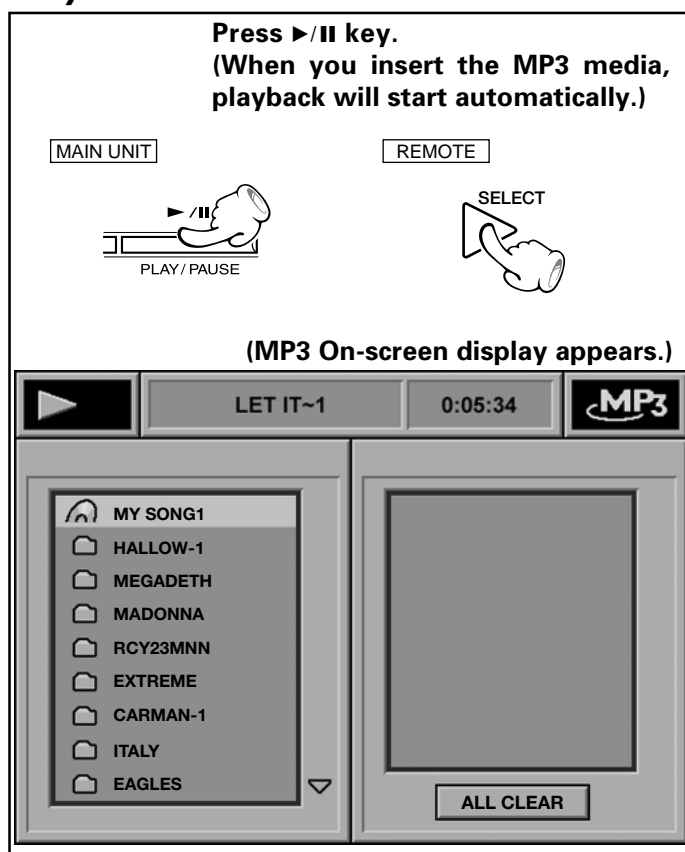

Operations

To stop playback

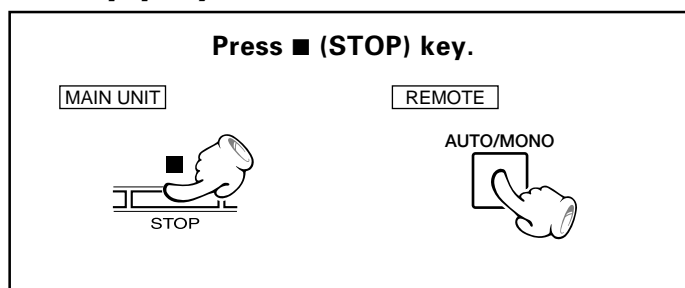

Skipping files

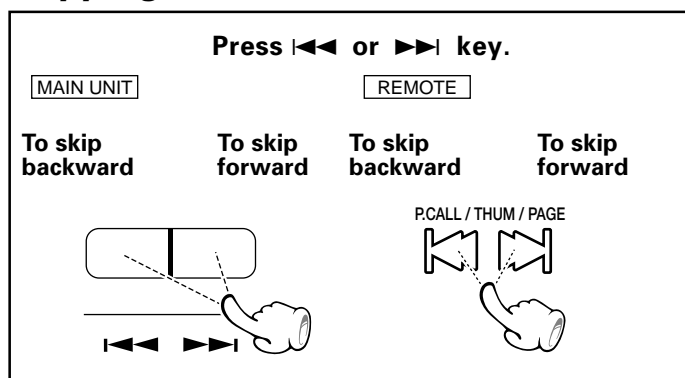

Selecting MP3 files or folders

Selects the files to be played back directly.

- 1 Press Cursor up/down (▲/▼) keys on the remote to select the folder, then press the ENTER key.

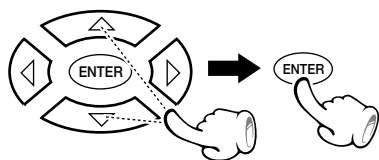

- 2 Press Cursor up/down (▲/▼) keys on the remote to select the file, then press the ENTER key.

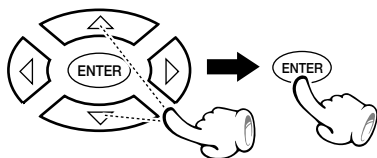
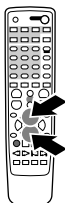

- Playback will start from selected file.
- Files in the next folder will be played back when no files exit in the selected folder.

- The files and folders in the selected folder appear.



- Press ENTER key on RETURN folder icon to move to the upper layer.



Selects the folders to be played back directly.

- 1 During stop mode, press Cursor up/down (▲/▼) keys on the remote to select the folder, then press the ENTER key.

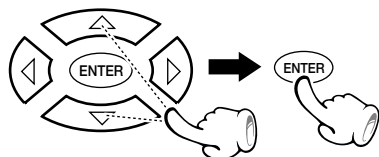

- 2 Press Cursor up/down (▲/▼) keys on the remote to select the upper folder icon, then press PLAY key.

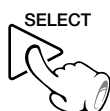

- Playback will start from selected folder.
- Files in the next folder will be played back when no files exit in the selected folder.





MP3 program playback

You can listen to the desired files of the current MP3 disc in any desired order.

Program Edit

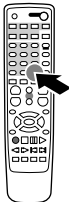
1 During stop mode, press the P.MODE key on the remote



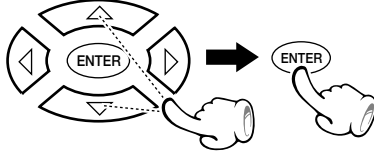

2 Press Cursor up/down (▲/▼) keys on the remote to select the file, then press the ENTER key.

- The selected file go to program window.
- You can select maximum 130 values by repeating step 2.
- 3 Press PLAY key to start program playback.
- Program playback will play back repeatedly.
- To return to standard play, press the P.MODE key again.

Goes off
PROG.

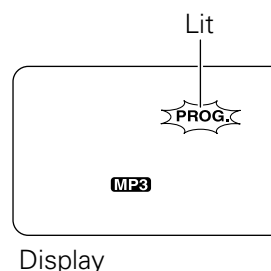

Delete Program

1 During stop mode, press Cursor left/right (◀/▶) keys on the remote to select the "ALL CLEAR" icon, then press the ENTER key.

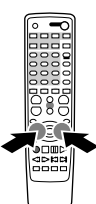
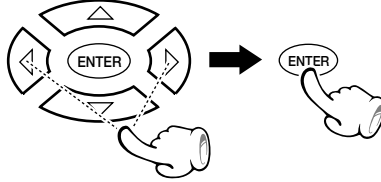
- The program deletes.
- You can delete file one by one by selecting in Program window and pressing CLEAR key on the remote.

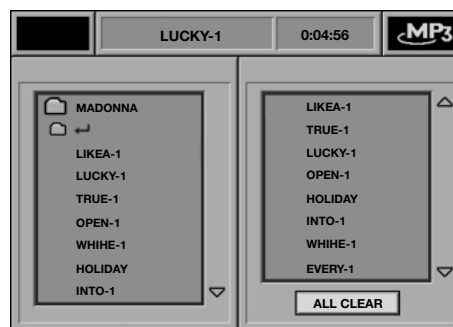

Set up menu

The initial setup of the player, which has been made at the factory, can be changed to the desired setup.

① During stop mode or resume mode, press MENU key on the remote.



Current setup menu display appears on the screen.

② Press Cursor up/down (▲/▼) keys on the remote to select the item, then press the ENTER key to access the sub features

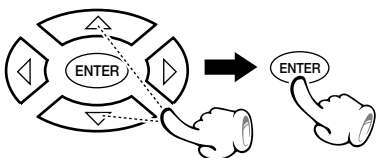
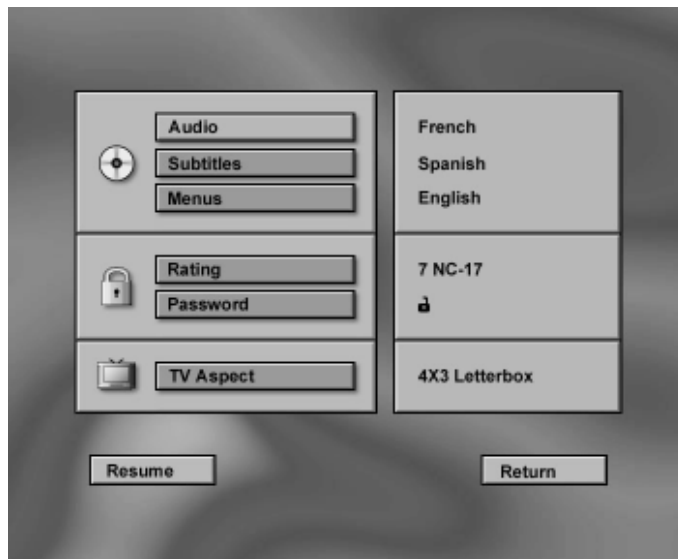
(Menu display example)

- Audio / Subtitle (disc languages)** : This sets the language to be used when playing a disc. (If a disc does not contain the recording the selected language, it is played in the priority language set for each disc.)
- Menus** : This sets the initial setup of language as well as the language used in on-screen messages such as "PLAY".
- Rating** : This can restrict playback of adult-oriented DVD discs that you do not want to be seen by children.
However, even when a DVD disc is marked "Adult-oriented" or so on the label, its viewing cannot be restricted unless the restriction level is recorded in the disc itself.
- Password** : The password for rating setting, change, cancellation, etc. is set.
- TV Aspect** : This sets the screen size (4:3 or 16:9 aspect ratio) according to the connected TV.
- 4 x 3 letterbox** : Choose this setting if you would prefer to see movies in their original aspect ratio. You will see the entire frame of the movie, but it will occupy a smaller portion of the screen. This setting may result in the movie appearing with black bars at the top and bottom of the screen.
 - 4 x 3 Pan Scan** : Choose this setting if you want the movie to fill the entire screen of your TV. You won't see part of the picture (particularly the right and left edge).
Some disc produced in a wide screen format can't be cropped in this fashion, which means the black bars would appear at the top and the bottom of the screen.
 - 16 x 9 Widescreen** : Choose this setting if your DVD player is connected to a widescreen TV.

How to use the RETURN key

When the RETURN key is pressed, the display returns to the previous screen (STOP mode).



DVD Select Audio Language

- Press Cursor up/down (▲/▼) keys on the remote to select Audio on the set up menu display, then press the ENTER key.

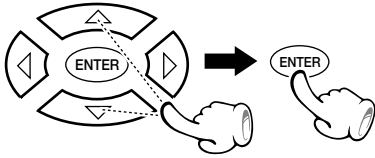
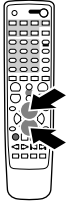

(Audio menu appears.)



(The display shows an example for some areas)

- Press Cursor up/down (▲/▼) keys on the remote to select specific Audio language, then press the ENTER key.

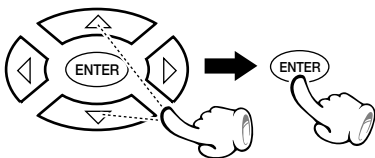
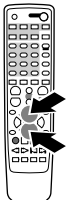

To select other language

- Select "Other" and press ENTER key



- Input code in the first digit by Press Cursor up/down (▲/▼) keys or numeric keys on the remote and repeat other 3 code with same way.
- Press the ENTER key on "OK" icon.
(DVD menu language code list → 54)

● Press PLAY key to resume normal playback.

DVD Select Subtitle Language

- Press Cursor up/down (▲/▼) keys on the remote to select Subtitle on the set up menu display, then press the ENTER key.

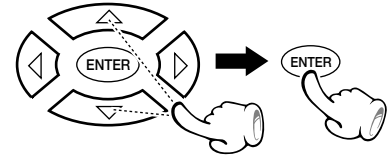

(Subtitle menu appears.)



(The display shows an example for some areas)

- Press Cursor up/down (▲/▼) keys on the remote to select specific Subtitle language, then press the ENTER key.

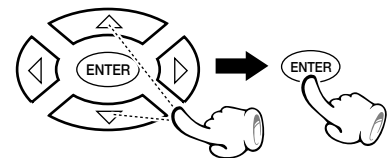

To select other language

- Select "Other" and press ENTER key



- Input code in the first digit by Press Cursor up/down (▲/▼) keys or numeric keys on the remote and repeat other 3 code with same way.
- Press the ENTER key on "OK" icon.
(DVD menu language code list → 54)

● Press PLAY key to resume normal playback.

DVD Select Menu Language

- Press Cursor up/down (▲/▼) keys on the remote to select Menus on the set up menu display, then press the ENTER key.

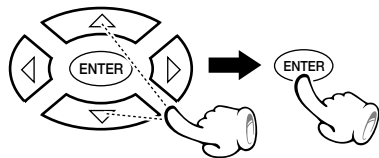

(Menu appears.)



(The display shows an example for some areas)

- Press Cursor up/down (▲/▼) keys on the remote to select specific Menu language, then press the ENTER key.

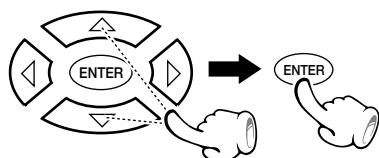

- Press PLAY key to resume normal playback.

DVD Select Rating

This part of DVD rating lets you determine how your player will react discs that contain movies that are rated (in the U.S.A. the Motion Pictures Association of America rates movies as G, PG, PG-13, etc.).

- Press Cursor up/down (▲/▼) keys on the remote to select Rating on the set up menu display, then press the ENTER key.

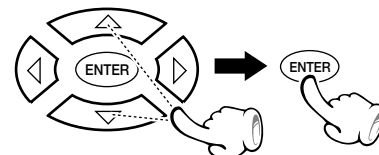
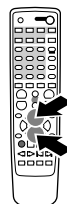

When a password already has been set, the screen for change of the entered password will be displayed. In that case, enter the password. (- 41)

(Rating aspect menu appears.)

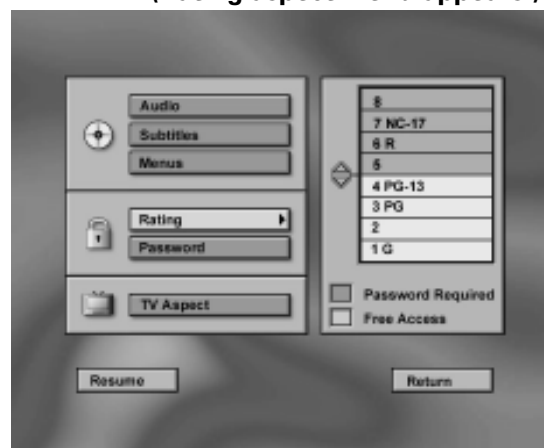

(The display shows an example for some areas)

- Press Cursor up/down (▲/▼) keys on the remote to highlight rated titles, then press the ENTER key.

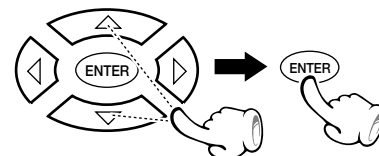

- Press PLAY key to resume normal playback.

Playback of a disc

When the settings for Rating (Parental Lock) and Password (see page 41) have been made, the input screen for the password will be displayed when playback of a disc corresponding to parental lock is started. Playback of that disc will be possible when the correct password has been entered.

Parental lock level

Level 8: All DVDs can be played back. (Factory preset)
 Level 7 to 2: DVDs for general audiences/children can be played back. (DVDs for adults are prohibited.)
 Level 1: DVDs for children can be played back. (DVDs for adults/general audiences are prohibited.)

DVD Password

Input password

- 1 Press Cursor up/down (▲/▼) keys on the remote to select Password on the set up menu display, then press the ENTER key.

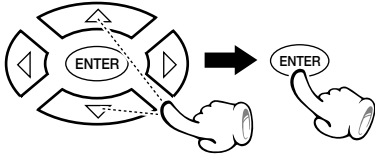
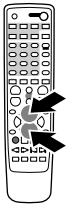

(Password menu appears.)



- 2 After select "Set Password", press the ENTER key.

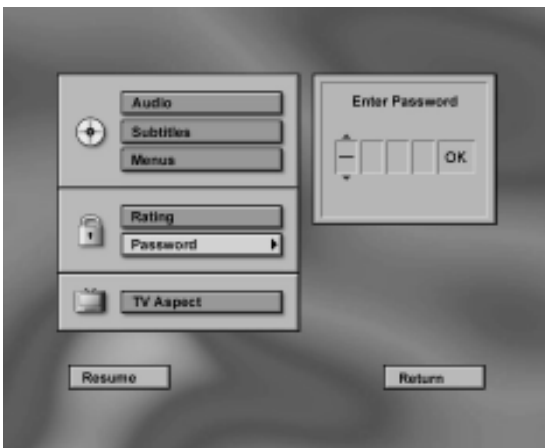
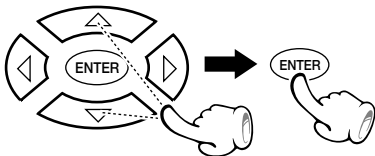

- 3 Press Cursor up/down (▲/▼) keys or numeric keys on the remote to enter password.

- 4 Press ENTER key to finish password input (Confirm Password display appears below Enter Password display).

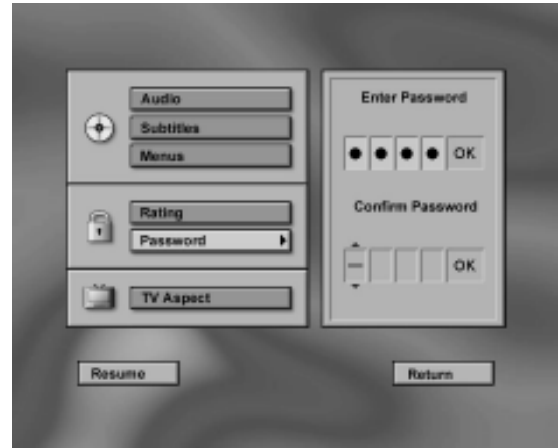

- 5 Press Cursor up/down (▲/▼) keys or numeric keys on the remote to enter again password that you entered.

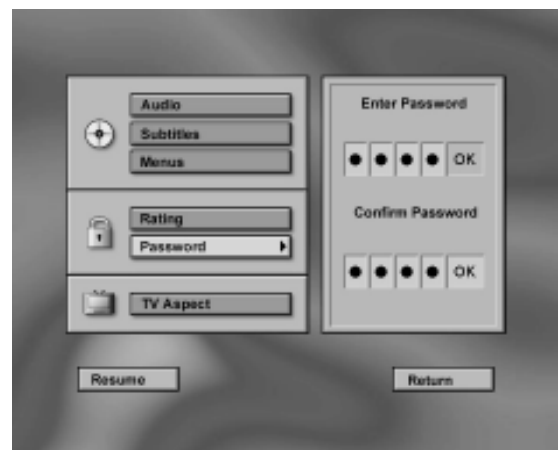
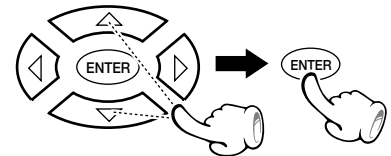

- 6 Press the ENTER key on "OK" icon.

- Press PLAY key to resume normal playback.

DVD Password (continued)

Change password

- ① Press Cursor up/down (▲/▼) keys on the remote to select Password on the set up menu display, then press the ENTER key.

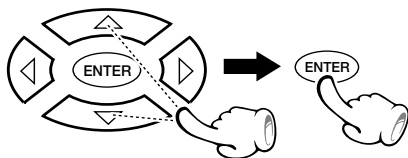
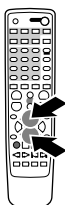

(Enter Password menu appears.)



- ② Press Cursor up/down (▲/▼) keys or numeric keys on the remote to enter password. Press the ENTER key on "OK" icon.

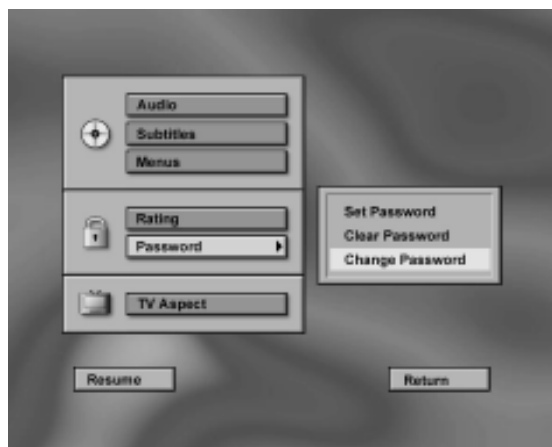
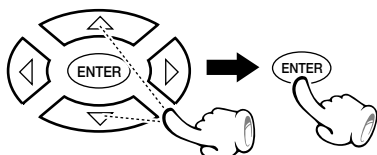
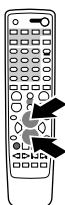

- ③ Press Cursor up/down (▲/▼) keys to select Change Password, then press ENTER key.

- ④ Press Cursor up/down (▲/▼) keys or numeric keys on the remote to enter password.

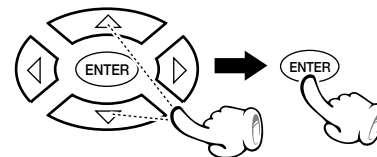

- ⑤ Press ENTER key to finish password input (Confirm Password display appears below Enter Password display).

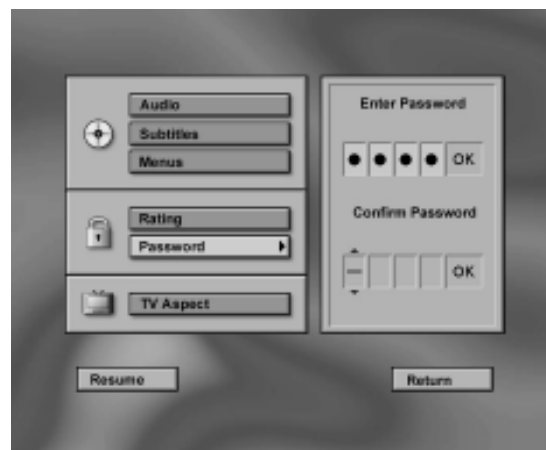

- ⑥ Press Cursor up/down (▲/▼) keys or numeric keys on the remote to enter again password that you entered.

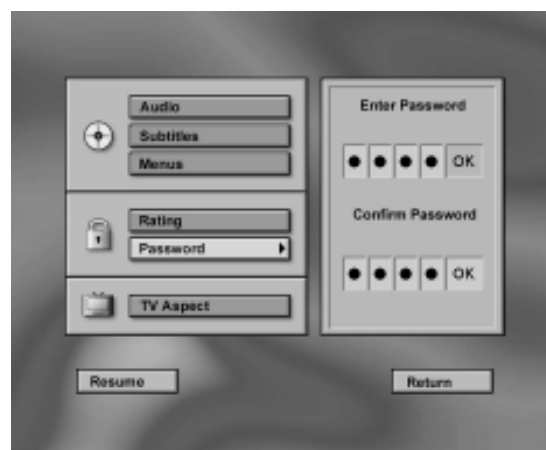
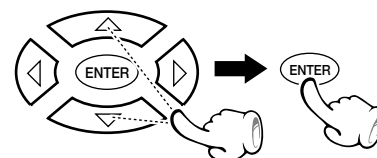

- ⑦ Press the ENTER key on "OK" icon.

- Press PLAY key to resume normal playback.

DVD Password (continued)

Clear password

① Press Cursor up/down (▲/▼) keys on the remote to select Password on the set up menu display, then press the ENTER key.

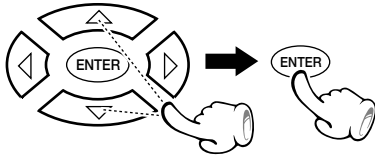

(Enter Password menu appears.)



② Press Cursor up/down (▲/▼) keys or numeric keys on the remote to enter password. Press the ENTER key on "OK" icon.

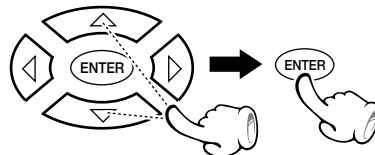

③ Press Cursor up/down (▲/▼) keys to select Clear Password, then press ENTER key.

● Press PLAY key to resume normal playback.

DVD TV aspect

① Press Cursor up/down (▲/▼) keys on the remote to select TV Aspect on the set up menu display, then press the ENTER key.

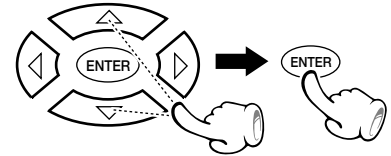

(TV Aspect menu appears.)



② Press Cursor up/down (▲/▼) keys on the remote to select TV Aspect menu, then press the ENTER key.

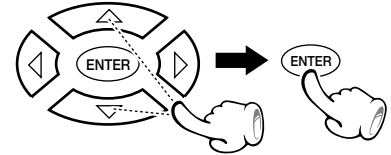

● Press PLAY key to resume normal playback.

What are LISTEN modes?

You can experience true home-theater sound with your new system. This system incorporates several listen modes to let you enjoy surround sound with a wide variety of program sources. Each produces multiple channels of surround-sound, but each does it differently.

- **Dolby Digital:** Dolby Digital uses an encode/decode process based on its theatrical digital surround sound technology. The five main channels are full-frequency and independent, so sound can completely envelop you or soar anywhere in the room, just like at the movies.
Compared with Dolby Pro Logic, Dolby Digital has more clarity, greater surround envelopment, and more realistic sound movement between channels.
- **Dolby Pro Logic/Dolby Pro Logic II:** Dolby Pro Logic reproduces a surround sound like in a movie theater from Dolby Surround-encoded program source (videotape or LaserDisc software carrying the Dolby Surround logo), and features excellent sound movement on the front and a surrounding atmosphere of movie theaters. Meanwhile, Dolby Pro Logic II decodes a signal encoded in 2 channels into 5-channel signals composed of the left/right front signals, center signal and surround left/right signals.
Dolby Pro Logic II is an advanced version of the decoding technology used with Dolby Pro Logic. It inputs 2-channel signals from a Dolby Surround-encoded source and reproduces 5-channel signals in which the surround channel is divided into independent channels for the left and right. Dolby Pro Logic II has the MOVIE mode and MUSIC mode, and the MUSIC mode enables independent adjustment of three parameters including Panorama mode, Dimension and Center Width.
- **DTS:** DTS has five full-frequency channels that create effects nearly identical to those in a theater. Sounds seem to zoom from one place to another or entirely surround you. Like Dolby Digital, DTS has much-improved clarity, surround and sound movement capability compared with Dolby Pro Logic. This listen mode is available on CD, LD, and DVD media. DTS is a strictly digital format that can be supplied only by a CD, LD, or DVD player that supports DTS sound.
- **DSP (Digital Signal Processing):** DSP allows you to create your own custom surround sound environments and use them with any source (except Dolby Digital and DTS). You can select the ambience of an ARENA, JAZZ CLUB, THEATER, STADIUM or DISCO to your taste.
- **CS5.1 ch:** The Circle Surround System was developed to provide the highest level of sonic performance available in a Matrix system. Audio for music was not the focus for other multichannel formats and, as a result, there is a serious compromise in the performance of these systems. That is not to say that the Circle Surround system is only for music—other applications such as Cinema, Home Theater, multichannel broadcast, video tape and any other type of audio delivery can take advantage of the superior performance of Circle Surround.
- **Stereo:** Stereo listen mode provides standard stereo sound to the front left and right speakers.

Description of Dolby Pro Logic II: Music mode

Panorama mode : Expands the image of front-channel stereo to the surround speakers to create a sound environment that fills your surroundings. (To change the Panorama mode, press **SOUND** key at the time of Dolby Pro Logic II Music mode. Display the **PANO R OFF** or **ON**, then press the **TRIM** (▲/▼) keys to select **ON** or **OFF**.)

Dimension : This controls the balance between the Front and Rear in 2 steps on the front and 2 steps on the rear. Set this parameter to one of the Front steps if the surround effect is too strong, or to one of the Back steps if it is too weak. (To change the Dimension, press **SOUND** key twice at the time of Dolby Pro Logic II Music mode. Display the **DIMEN 0** (or other value), then press the **TRIM** (▲/▼) keys to select **F-2**, **F-3**, **R-2** or **R-3**.)

Center Width : The center channel signal can be divided and distributed to the Front L/R channels.

The adjustment for distributing the center channel signal to the front channels can be applied in eight steps from 0 to 7. Use this adjustment when the center image seems to be too strong. (To change the Center Width, press **SOUND** key 3 times at the time of Dolby Pro Logic II Music mode. Display the **C WIDTH 3** (or other value), then press the **TRIM** (▲/▼) keys to select **0 ~7**.)

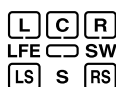

The INPUT/OUTPUT status indicator becomes an input indicator at the time of DOLBY DIGITAL and DTS source and an output indicator at all other times.

To set the LISTEN mode manually

According to the contents of the disc played in this unit, the LISTEN MODE (selected by the LSTN M. key) can be found in the following table

SOURCE LISTEN MODE	DISC				Input	
	DOLBY DIGITAL (5.1ch)	DOLBY DIGITAL (2ch)	DTS	VCD/CD (PCM, MP3)	*VCR, SAT/CABLE and FRONT Digital COAX/OPTI	VCR, SAT/CABLE and FRONT ANALOG
DOLBY DIGITAL	○	○			○	
DTS			○		○	
DOLBY PRO LOGIC II		○		○	○	○
DOLBY PRO LOGIC		○		○	○	○
CIRCLE SURROUND (CS-5.1)				○	○	○
DSP ARENA JAZZ CLUB THEATER STADIUM DISCO				○	○	○
STEREO	○	○	○	○	○	○

The indicator for the presently selected LISTEN mode will light.



*Selectable Listen modes by VCR, SAT/ CABLE and FRONT Digital input differs according to the input source.

Press the LSTN MODE key.

REMOTE

Each press switches the modes as shown below.

(At the time of PCM source)

- ① DOLBY PL II MOVIE
- ② DOLBY PL II MUSIC
- ③ DOLBY PRO LOGIC
- ④ CIRCLE SURROUND
- ⑤ ARENA
- ⑥ JAZZ CLUB
- ⑦ THEATER
- ⑧ STADIUM
- ⑨ DISCO
- ⑩ STEREO

(At the time of DTS source)

- ① DTS
- ② DTS STEREO

(At the time of DOLBY DIGITAL source)

- ① DOLBY DIGITAL
- ② STEREO

Manufactured under license from Dolby Laboratories. "DOLBY", "Pro Logic" and the double-D symbol are trademarks of Dolby Laboratories.

"DTS" and "DTS Digital Surround" are trademarks of Digital Theater Systems, Inc.

Sound Retrieval System manufactured under licence from SRS Labs, Inc. "SOUND RETRIEVAL SYSTEM" and the SRS Symbol SRS (●) are trademarks of SRS Labs, Inc. Purchase of this product does not convey the right to sell recordings made with the SOUND RETRIEVAL SYSTEM.

DTS disclaimer clause

DTS Digital Surround™ is a discrete 5.1 channel digital audio format available on CD, LD, and DVD software which consequently cannot be decoded and played back inside most CD, LD, or DVD players. For this reason, when DTS-encoded software is played back through the analog outputs of the CD, LD, or DVD player, excessive noise will be exhibited. To avoid possible damage to the audio system, proper precautions should be taken by the consumer if the analog outputs are connected directly to an amplification system. To enjoy DTS Digital Surround™ playback, an external 5.1 channel DTS Digital Surround™ decoder system must be connected to the digital output (S/P DIF, AES/EBU, or TosLink) of the CD, LD or DVD player. This unit is equipped with DTS Digital Surround™ decoder.

Positioning the speakers

To achieve the optimum effects obtainable with this SURROUND SOUND system, it is important to position the speakers properly. Refer to the following illustration to find the best location in your room.

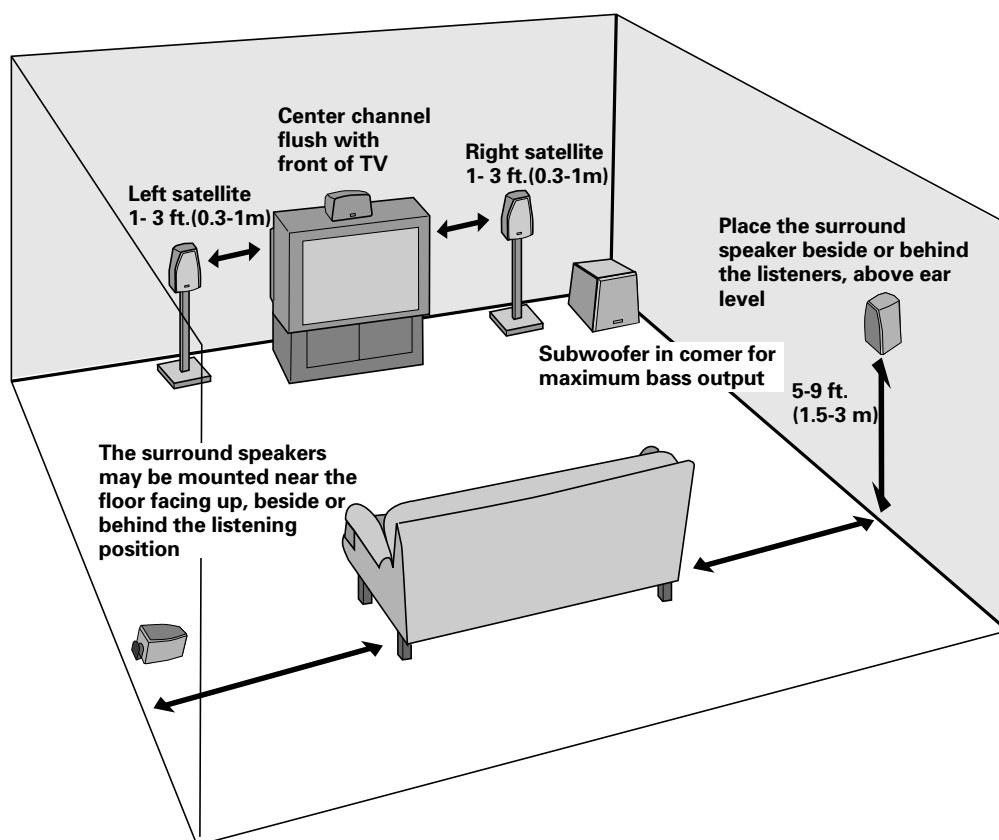
**Center Channel**

Place the unity center channel on top of the video monitor or TV set. The front of the speaker should be flush with the front of the television.

Subwoofer

The level of bass output from the subwoofer will vary at different positions in the room

Corner placement provides the most bass output, while placement near only one wall provides somewhat less bass. Since low bass sounds are omnidirectional-the ear can't tell from which direction they're coming-the subwoofer can be located out of sight in the corner of the room, yet all the sound, including the bass, appears to come from the Unity's front speakers.

Front Satellite Speakers

The best location for the front speakers is to either side of the video monitor or TV. The speakers can be wall-mounted, or placed on a bookshelf, with equally good results.

Rear Satellite Speakers

The best location for the rear speakers is to the side and slightly behind the listeners. The speakers can be wall-mounted facing out, as shown. It may be easier to run wire to the speakers if they are mounted near the floor, facing up towards the ceiling. This position will produce excellent surround results. Mounting brackets for both options are included.

Speaker level setting

For this unit, the speaker levels have been set in advance so that the best volume balance is obtained with standard use.

Reset as follows to match your listening environment.

- 1 Play a disc marked "Dolby Digital".
- 2 Stop the playback.
- 3 Press TEST key for more than 2 seconds
- 4 Press the TRIM (▲/▼) keys to control the speaker level.
- 5 Press TEST (SOUND/NIGHT) key to resume normal mode.

The test tone is played back from the Left Front speaker. Adjust the **VOLUME CONTROL** so that it is slightly loud and fix it there.

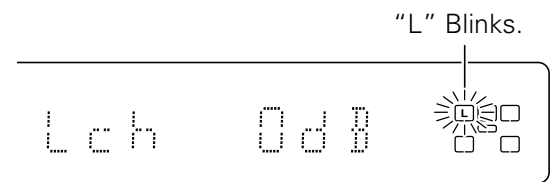

The speakers will be switched as follows in intervals of about 2 seconds.

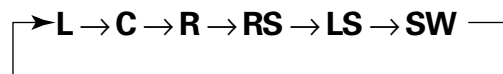

Adjust the volume with the TRIM (▲/▼) keys while the indicator is flashing so that the volume from all speakers except the subwoofer (SW) appears the same.

- The level of Front speakers, Center speaker and Surround speakers adjustment are possible in the range from -6 dB to +6 dB.

The level of Subwoofer adjustment is possible in the range from -9 dB to +9 dB.



As the subwoofer (SW) has a special playback band, normal adjustment is not possible with the test tone. Please adjust the subwoofer while listening to actual music. (→ 48)

Level setting using a music source

A music source can be used for speaker level setting and subwoofer level setting.

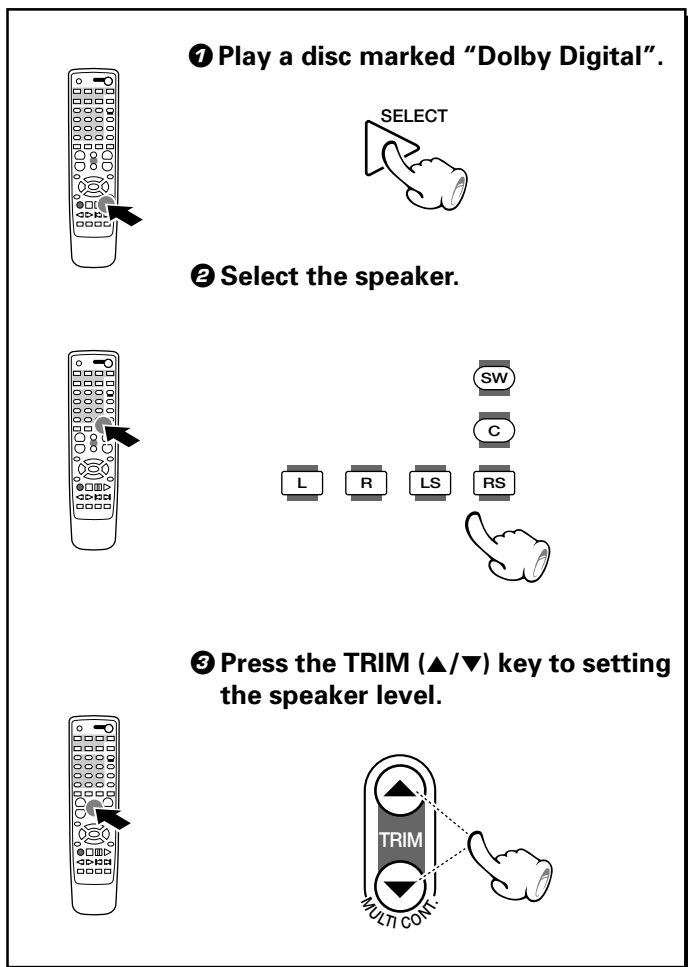

Speaker level adjustment can be performed by pressing the keys L, R, SL, SR, C and SW.

- L : Left front speaker
- R : Right front speaker
- LS : Left Surround speaker
- RS : Right Surround speaker
- C : Center speaker
- SW : Subwoofer

- The level of Front speakers, Center speaker and Surround speakers adjustment are possible in the range from -6 dB to +6 dB.
The level of Subwoofer adjustment is possible in the range from -9 dB to +9 dB.
- The mode is switched off when no operation is performed for about 5 seconds.

Changing the INPUT MODE

The input mode can be switched with VCR, SAT/CABLE and FRONT.

For listening to VCR, SAT/CABLE and FRONT input with high sound quality, connect the digital output of your satellite tuner with coaxial or optical cable and change the input mode as follows.

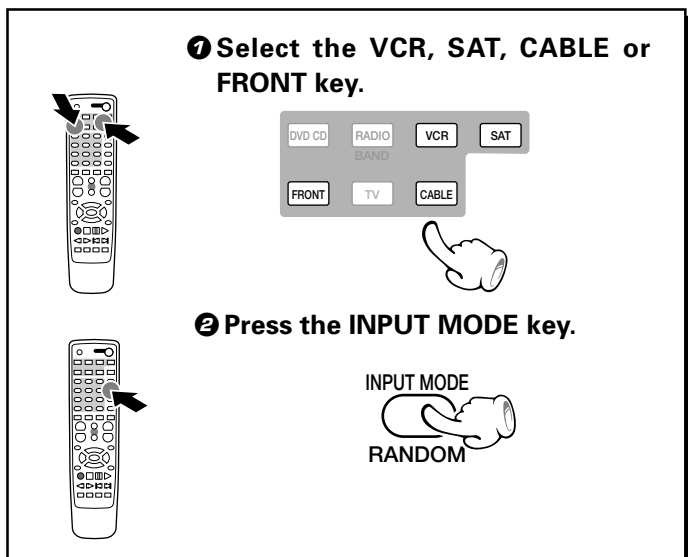

When the video is displayed, but no sound is put out, the source may not contain digital audio. In such a case, please switch to ANALOG.

Each press switches the mode.

- VCR, SAT and CABLE input**
- ① ANALOG
 - ② COAXIAL
 - ③ OPTICAL

- FRONT input**
- ① ANALOG
 - ② OPTICAL

Register the setup codes for your audio and video

The devices which can be set up are VCR SAT (satellite tuner), TV, and CABLE TV).

① Press one of the devices key for more than 2 seconds

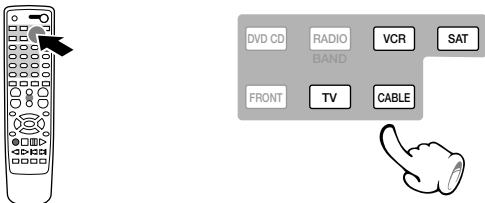

② Use the numeric keys to enter the setup code.

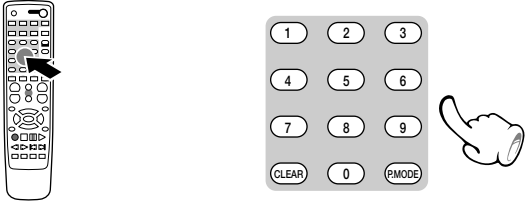

③ Press DEVICE (I/⏻) key, CH +/- keys or numeric keys to test the code.

If the code is acceptable, your devices work as it is.

The LED on the remote control unit lights.



Refer to the code table and enter the 4-digit setup code while the LED on the remote control unit is lit. (→ 50)

- The LED goes out when the code is not correct or not recognized.
- When the setup code has been recognized, the LED flashes 3 times and setup is completed.

Operating other devices

① Press one of devices key for operate.

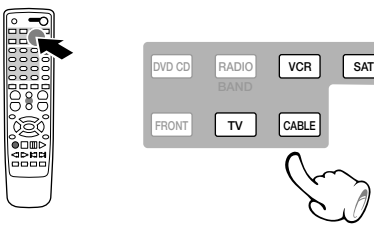

② Press DEVICE I/⏻. key to de- vise power on.

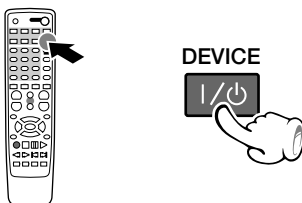

③ Press devise operate key.
(Keys which can be used to operate connected devices (→ 53))

Setup code table

TV

BRAND	Setup codes			
ADMIRAL	0108	0478		
AIKO	0107			
AKAI	0045			
ALARON	0194			
AMERICA ACTION	0195			
AMPRO	0766			
ANAM	0195			
AOC	0034	0045		
AUDIOVOX	0107	0195	0466	
BAYSONIC	0195			
BELCOR	0034			
BELL & HOWELL	0031	0169		
BRADFORD	0195			
BROCKWOOD	0251	0478		
CANDLE	0045	0071		
CARNIVALE	0045			
CARVER	0069			
CELEBRITY	0015			
CINERAL	0107	0466		
CITIZEN	0045	0071	0075	0107
CONCERTO	0071			
CONTEC	0195			
CRAIG	0195			
CROSLEY	0069			
CROWN	0195			
CURTIS MATHES	0031	0045	0062	0066
	0069	0071	0075	0108
	0160	0169	0181	0466
	0481	1162	1362	
CXC	0195			
DAEWOO	0034	0107	0466	
DAYTRON	0034			
DENON	0160			
DUMONT	0032	0034		
DWIN	0735	0789		
ELECTROBAND	0015			
EMERSON	0034	0169	0193	0194
	0195	0251	0297 0478	
ENVISION	0045			
FISHER	0169			
FUJITSU	0194	0698		
FUNAI	0186	0194	0195	
FUTURETECH	0195			
GE	0036	0062	0066	0108
	0193	0297	0466	1162
	1362			
GIBRALTER	0032	0034	0045	
GRADIENTE	0068	0071		
GRUNPY	0194	0195		
HALLMARK	0193			
HARLEY DAVIDSON	0194			
HARMAN/KARDON	0069			
HARVARD	0195			
HITACHI	0031	0071	0160	
INFINITY	0069			
INTEQ	0032			
JBL	0069			
JCB	0015			
JVC	0068			
KEC	0195			
KENWOOD	0034	0045		
KTV	0045	0195		

BRAND	Setup codes			
LG(GOLDSTAR)	0034	0045	0071	0193
LOGIK	0031			
LUXMAN	0071			
LXI	0062	0069	0169	0171
	0193			
MAGNAVOX	0045	0069	0194	
MAJESTIC	0031			
MARANTZ	0045	0069		
MATSUSHITA	0265			
MEGATRON	0160	0193		
MEMOREX	0031	0071	0165	0169
	0193	0265	0478	
MGA	0034	0045	0165	0193
MIDLAND	0032	0062	0066	
MINUTZ	0036			
MINITUBISHI	0034	0108	0165	0193
MOTOLORA	0108			
MTC	0034	0045	0071	0075
MULTITECH	0195			
NAD	0171	0181	0193	
NEC	0034	0045	0071	
NIKKO	0045	0107	0193	
NTC	0107			
ONWA	0195			
OPTIMUS	0169	0181	0265	
OPTONICA	0108	0180		
ORION	0194	0251	0478	
PANASONIC	0034	0036	0045	0062
	0066	0071	0075	0171
	0193	1362		
PHILCO	0034	0045	0069	0160
	0478			
PHILIPS	0069			
PILOT	0034	0045		
PIONEER	0181			
PORTLAND	0034	0107		
PRISM	0066			
PROSCAN	0062			
PROTON	0193	0481		
PULSAR	0032	0034		
QUASAR	0066	0180	0265	
RADIOSHACK	0034	0045	0062	0071
	0169	0180	0193	0195
RCA	0034	0062	0066	0105
	0108	1062	1162	1262
	1362	1462		
REALISTIC	0034	0045	0071	0169
	0180	0193	0195	
RUNCO	0032	0045		
SAMPO	0045			
SAMSUNG	0034	0045	0071	0075
	0193			
SANSEI	0466			
SANSUI	0478			
SANYO	0169			
SCIMITSU	0034			
SCOTCH	0193			
SCOTT	0034	0193	0194	0195
	0251			
SEARS	0062	0069	0071	0169
	0171	0186	0193	0194
SEMIVOX	0195			

BRAND	Setup codes			
SEMP	0171			
SHARP	0108	0180		
SHOGUN	0034			
SIGNATURE	0031			
SONY	0015			
SOUNDESIGN	0193	0194	0195	
SSS	0034	0195		
STARLITE	0195			
SUPREME	0015			
SQUAREVIEW	0186			
SYLVANIA	0045	0069		
SYMPHONIC	0186			
TANDY	0108			
TECHNICS	0066	0265		
TECHNOL ACE	0194			
TECHWOOD	0066	0071		
TEKNIKA	0031	0034	0069	0071
	0180	0193	0194	
TMK	0071	0193		
WHITE WESTINGHOUSE	0478			
YAMAHA	0034	0045		
ZENITH	0031	0032	0107	0478

Setup code table (continued)**VCR**

BRAND	Setup codes			
ADMIRAL	0063	0224		
AIKO	0293			
AIWA	0015	0052		
AKAI	0056	0064	0068	
AMERICA ACTION	0293			
AMERICAN HIGH	0050			
ASHA	0255			
AUDIOVOX	0052			
BEAUMARK	0255			
BELL & HOWELL	0119			
BROCKSONIC	0224			
BROKSONIC	0017	0136	0199	0224
	0376			
CALIX	0052			
CANON	0050			
CARVER	0096			
CCE	0087	0293		
CINERAL	0293			
CITIZEN	0052	0293		
COLT	0087			
CRAIG	0052	0062	0087	0255
CURTIS-MATHES	0050	0056	0075	0177
CYBERNEX	0066	0255		
DAEWOO	0060	0293		
DENON	0057			
DYNATECH	0015			
ELECTROHOME	0052			
ELECTROPHONIC	0052			
EMEREX	0047			
EMERSON	0015	0017	0051	0052
	0058	0083	0103	0136
	0199	0224	0293	0376
FISHER	0062	0069	0119	
FUJI	0048	0050		
FUNAI	0015			
GARRARD	0015			
GE	0050	0063	0075	0255
GRADIENTE	0015	0023		
HARLEY DAVIDSON	0015			
HARMAN KARDON	0053	0096		
HARWOOD	0083	0087		
HEADQUARTER	0061			
HI Q	0062			
HITACHI	0015	0056	0057	0097
	0181			
HUGHES NETWORK SYSTEMS	0057			
JENSEN	0056			
JVC	0023	0056	0082	
KEC	0052	0293		
KENWOOD	0053	0056	0082	
KLH	0087			
KODAK	0050	0052		
LG (GOLDSTAR)	0052	0053		
LLYOD'S	0015			
LOGIK	0087			
LXI	0052			
MAGGIN	0255			
MAGNASONIC	0293			
MAGNAVOX	0015	0050	0054	0096
MARANTZ	0050	0096		
MARTA	0052			

BRAND	Setup codes			
MATSUSHITA	0050	0177		
MEI	0050			
MEMOREX	0015	0050	0052	0054
	0061	0062	0063	0119
	0177	0224	0255	1052
	1177	1277		
MGA	0058	0255		
MGN TECHNOLOGY	0255			
MINOLTA	0057			
MITSUBISHI	0058	0063	0082	
MOTOROLA	0050	0063		
MTC	0015	0255		
MULTITECH	0015	0087		
NAD	0073			
NEC	0053	0055	0056	0082
	0097	0119		
NIKKO	0052			
NIKON	0049			
NOBLEX	0255			
OLYMPUS	0050			
OPTIMUS	0052	0063	0073	0119
	0177	1063	1077	1177
	1277			
ORION	0017	0199	0224	
PANASONIC	0050	0177	0631	1077
	1177	1277		
PENNEY	0050	0052	0053	0055
	0057	0069	0255	
PENTAX	0057			
PHILCO	0050	0224		
PHILIPS	0050	0096	0633	
PILOT	0052			
PIONEER	0073	0082		
PROFITRONIC	0255			
PROSCAN	0075			
PROTEC	0087			
PULSAR	0054	0066		
QUARTER	0061			
QUARTZ	0061			
QUASAR	0050	0177	1177	
RADIO SHACK	0015	1052		
RADIX	0052			
RANDEX	0052			
RCA	0050	0057	0063	0075
	0255			
REALISTIC	0015	0050	0052	0061
	0062	0063	0119	
REPLAYTV	0629	0631		
RICOH	0049			
RUNCO	0054			
SAMSUNG	0060	0066	0068	0255
SANKY	0054	0063		
SANSUI	0015	0056	0082	0097
	0224			
SANYO	0061	0062	0119	0255
SCOTT	0058	0060	0136	0199
SEARS	0015	0050	0052	0057
	0061	0062	0069	0119
SEMP	0060			
SHARP	0063			
SHINTOM	0087			
SHOGUN	0066	0255		

BRAND	Setup codes			
SINGER	0087			
SONY	0015	0047	0048	0049
	0050			
STS	0057			
SYLVANIA	0015	0050	0058	0096
SYMPHONIC	0015			
TATUNG	0056			
TEAC	0015	0056		
TECHNICS	0050	0177		
TEKNIKA	0015	0050	0052	0067
THOMAS	0015			
TIVO	0633			
TMK	0051	0255		
TOSHIBA	0058	0060		
TOTEVISION	0052	0255		
UNITECH	0255			
VECTOR	0060			
VECTOR RESEARCH	0053	0055		
VIDEO CONCEPTS	0055	0060		
VIDEOSONIC	0255			
WARDS	0015	0050	0057	0062
	0063	0075	0087	0096
	0255			
WHITE	0224	0293		
WESTINGHOUSE				
XR-1000	0015	0050	0087	
YAMAHA	0053			
ZENITH	0015	0048	0049	0054
	0224			

Setup code table (continued)

CABLE

BRAND	Setup codes			
ABC	0018	0023	0026	0028
	0029	0048	0062	
BELL&HOWELL	0029			
COMBAND	0247			
COMTRONICS	0055			
CONTEC	0034			
ELECTRICORD	0093			
EVERQUEST	0030	0055		
GE	0247			
GEMINI	0030			
GENERAL	0026	0291	0491	
INSTRUMENTS				
HITACHI	0026			
JASCO	0030			
JERROLD	0018	0026	0027	0029
	0030	0062	0291	
LG(GOLDSTAR)	0055	0159		
MACOM	0048			
MEMOREX	0015			
MOVIE TIME	0078	0093		
NSC	0078			
OAK	0034	0263		
OPTIMUS	0036			
PANASONIC	0015	0036	0122	
PARAGON	0015			
PHILIPS	0305			
PIONEER	0038	0159	0548	0892
PULSAR	0015			
QUASAR	0015			
RADIOSHACK	0030			
RCA	0036			
REMBRANDT	0026			
RUNCO	0015			
SAMSUNG	0055	0159		
SCIENTIFIC ATLANTA	0023	0292	0492	0892
SIGNAL	0030	0055		
SIGNATURE	0026			
SL MARX	0055			
SPRUCER	0036			
STARCOM	0030	0055		
STARQUEST	0030			
TELEVIEW	0055			
TIMELESS	0433			
TOCOM	0027	0028		
TOSHIBA	0015			
TUSA	0030			
TV86	0078			
UNIVERSAL	0093	0206		
VIDEOWAY	0265			
VIEWSTAR	0078	0304		
ZENITH	0015	0540	0914	

SATELLITE

BRAND	Setup codes			
ALPHASTAR	0787			
AMWAY	0090			
CABLE INNOVATIONS	0569			
CHANNEL MASTER	0033			
CHAPARRAL	0068	0224		
CURTIS MATHES	0076			
DRAKE	0033	0081	0164	0165
DX ANTENNA	0056			
EHOSTAR	0163	0284	0295	0790
EXPRESVU	0790			
GENERAL	0053	0065	0376	0569
INSTRUMENTS	0642	0884		
HITACHI	0834			
HTS	0790			
HUGHES NETWORK	0764			
SYSTEMS				
IQ	0225			
IQ PRISM	0225			
JERROLD	0051	0376	0642	
JVC	0790			
KEMWOOD	0279			
LEGEND	0284			
MACOM	0033	0065	0076	
MAGNAVOX	0737	0739		
MEMOREX	0284	0739		
NEXT LEVEL	0884			
PANASONIC	0716			
PHILIPS	0737	0739		
PICO	0090			
PRIMESTAR	0376	0642		
RADIOSHACK	0569	0884		
RAMSEY	0090			
RCA	0158	0407	0581	0870
REALISTIC	0067			
SONY	0654			
STAR CHOICE	0884			
STAR TRAK	0195			
STARCAST	0057			
STS	0056	0225		
TOSHIBA	0076	0097	0805	
UNIDEN	0067	0089	0091	0569
	0737	0739		
ZENITH	0076	0871		

Keys which can be used to operate connected devices

Operation of the dark-colored keys in the figure is possible.

VCR

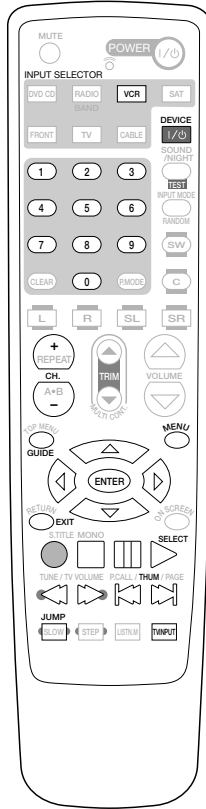

(Operation keys differing from the indication)

TV INPUT : TV/VCR
 ◀ ▶ : THUM B +/-

TV

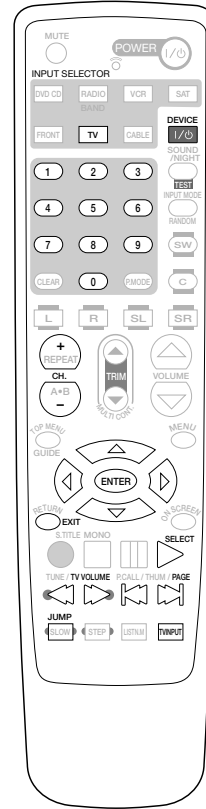

(Operation keys differing from the indication)

TV INPUT : TV/VCR
 STOP : MUTE
 ▶ ◀ : FF/REW
 ◀ ▶ : VOLUME +/-

CABLE

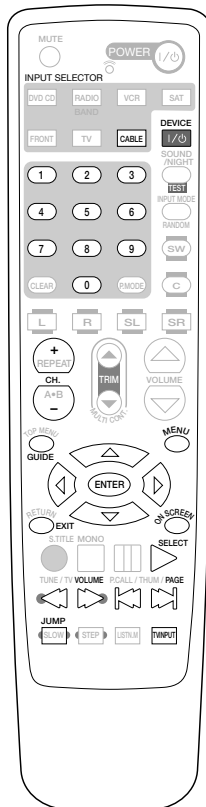

(Operation keys differing from the indication)

TV INPUT : INPUT
 ▶ ◀ : PAGE +/-
 ◀ ▶ : VOLUME +/-

SAT

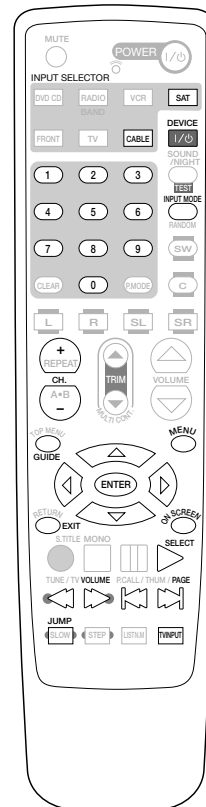

(Operation keys differing from the indication)

TV INPUT : INPUT

DVD menu language code list

Cord No.	Language
6565	Afar
6566	Abkhazian
6570	Afrikaans
6577	Amharic
6582	Arabic
6583	Assamese
6588	Aymara
6590	Azerbaijani
6665	Bashkir
6669	Byelorussian
6671	Bulgarian
6672	Bihari
6678	Bengali; Bangla
6679	Tibetan
6682	Breton
6765	Catalan
6779	Corsican
6783	Czech
6789	Welsh
6865	Danish
6869	German
6890	Bhutani
6976	Greek
6978	English
6979	Esperanto
6983	Spanish
6984	Estonian
6985	Basque
7065	Persian
7073	Finnish
7074	Fiji
7079	Faroese
7082	French
7089	Frisian
7165	Irish
7168	Scots Gaelic
7176	Galician
7178	Guarani
7185	Gujarati
7265	Hausa
7273	Hindi

Cord No.	Language
7282	Croatian
7285	Hungarian
7289	Armenian
7365	Interlingua
7378	Indonesian
7383	Icelandic
7384	Italian
7387	Hebrew
7465	Japanese
7473	Yiddish
7487	Javanese
7565	Geogian
7575	Kazakh
7576	Greenlandic
7577	Cambodian
7578	Kannada
7579	Korean
7583	Kashmiri
7585	Kurdish
7589	Kirghiz
7665	Latin
7678	Lingala
7679	Laothian
7684	Lithuanian
7686	Latvian; Lettish
7771	Malagasy
7773	Maori
7775	Macedonian
7776	Malayalam
7778	Mongolian
7779	Moldavian
7782	Marathi
7783	Malay
7784	Maltese
7789	Burmese
7865	Nauru
7869	Nepali
7876	Dutch
7879	Nowegian
7982	Oriya
8065	Punjabi

Cord No.	Language
8076	Polish
8083	Pashto; Pushto
8084	Portuguese
8185	Quechua
8277	Rhaeto-Romance
8279	Romanian
8285	Russian
8365	Sanskrit
8368	Sindhi
8372	Serbo-Croatian
8373	Singhalese
8375	Slovak
8376	Slovenian
8377	Samoan
8378	Shona
8379	Somali
8381	Albanian
8382	Serbian
8385	Sundanese
8386	Swedish
8387	Swahili
8465	Tamil
8469	Telugu
8471	Tajik
8472	Thai
8473	Tigrinya
8475	Turkmen
8476	Tagalog
8479	Tonga
8482	Turkish
8484	Tatar
8487	Twi
8575	Ukrainian
8582	Urdu
8590	Uzbek
8673	Vietnamese
8679	Volapük
8779	Wolof
8872	Xhosa
8979	Yoruda
9072	Chinese
9085	Zulu

What seems to be a malfunction is not always so. Before calling for service, check the following table according to the symptom of your trouble.

Operation to reset

The microcomputer may fall into malfunction (impossibility to operate, erroneous display, etc.) when the power cord is unplugged while power is ON or due to an external factor. In this case, execute the following procedure to reset the microcomputer and return it to normal condition.

Set the POWER switch to ON (set to Standby mode). Then press the ►►| key, ◀◀ key and STOP key in this order.

- Please note that resetting the microcomputer clears the contents stored in and returns and to condition when it left the factory.

Receiver, speakers

Symptom	Cause	Remedy
Sound is not produced.	<ul style="list-style-type: none"> ● The speaker cords are disconnected. ● The MUTE switch of remote control unit is switched ON. ● The headphone plug is inserted into the jack. ● The volume control of this set is not adjusted properly. 	<ul style="list-style-type: none"> ● Connect properly referring to "System connection". → 11 ● Switch MUTE OFF. → 17 ● Unplug the headphone plug. → 17 ● Set the sound volume to an appropriate level. → 17
Sound is not produced from the left or right speakers.	<ul style="list-style-type: none"> ● The speaker cords are disconnected. 	<ul style="list-style-type: none"> ● Connect properly referring to "System connection". → 11
Radio stations cannot be received.	<ul style="list-style-type: none"> ● The antennas have not been connected. ● A proper broadcasting band has not been selected. ● The frequency of the station to be received is not tuned. 	<ul style="list-style-type: none"> ● Connect antennas. → 12 ● Select a band. → 19 ● Tune to the frequency of the desired station. → 19
Noise interferes.	<ul style="list-style-type: none"> ● Car ignition noise. ● The accessory FM indoor antenna is being used. ● Influence of an electric appliance. ● A TV set is installed near the system. ● The connection of the AM loop antenna is not correct. 	<ul style="list-style-type: none"> ● Install the outdoor antenna in an apart position from the road. → 12 ● Use the outdoor antenna. → 12 ● Switch the suspected electric appliance OFF. → 12 ● Install the TV or the system at an increased distance between them. → 12 ● Connect the wire with the white tube to the lower side (+ side). → 12
A station has been preset but it cannot be received by pressing the P.CALL key.	<ul style="list-style-type: none"> ● The frequency of the preset station is not tunable. ● The preset memory has been cleared because the power cord has been unplugged for a long period or operated to reset. 	<ul style="list-style-type: none"> ● Preset stations with tunable frequencies. → 20 ● Preset stations again. → 20
Standby condition is reached by power ON.	<ul style="list-style-type: none"> ● The speaker cord connection is not correct or the operation of the microcomputer temporarily has become abnormal. 	<ul style="list-style-type: none"> ● Reset the microcomputer. → 55 ● Check the speaker connection. If this does not help, contact your dealer for service. → 11
Standby condition is reached suddenly while listening to music.	<ul style="list-style-type: none"> ● The temperature protection inside the unit has operated because of an excessive volume. 	<ul style="list-style-type: none"> ● Leave the unit for about 15 minutes in standby condition to cool down, and then perform power ON. During standby, the standby indicator will flash faster than normal, but when it goes out, the unit has returned to normal condition. If normal return is not obtained even when this operation has been repeated, contact your dealer for service.
No sound from the surround speakers	<ul style="list-style-type: none"> ● The LISTEN mode is STEREO. 	<ul style="list-style-type: none"> ● Select Surround with the LSTN M. key. → 45

Remote control unit

Symptom	Cause	Remedy
Remote control operation is not possible.	<ul style="list-style-type: none"> ● Batteries are exhausted. ● The remote control is too far away from the system, the controlling angle is deviated or there is an obstacle in between. ● There is no disc set in the component to be played. 	<ul style="list-style-type: none"> ● Replace with new batteries. → ● Operate the unit inside the remote controllable range. → ● Set a disc in the component to be played. →
	<ul style="list-style-type: none"> ● Operation has been performed with the keys of the main unit. ● A nonfunctional key has been pressed 	<ul style="list-style-type: none"> ● Perform operation after once pressing the key for the input or device to be operated. →

DVD / CD player unit

Symptom	Cause	Remedy
Playback does not start when the play (▶/II) key is pressed.	<ul style="list-style-type: none"> ● There is no disc in the player. ● There are no signals recorded on the side of the disc being played. 	<ul style="list-style-type: none"> ● Load a disc and press the play (▶/II) key. → ● Turn the disc over and properly place it on the disc tray. →
Playback starts but no image/sound is seen/heard.	<ul style="list-style-type: none"> ● The TV is not turned on. ● The connection cords are not properly connected. 	<ul style="list-style-type: none"> ● Turn on the TV. ● Properly reconnect the connection cords.
The picture is disrupted when the image is fast forwarded or fast reversed.	<ul style="list-style-type: none"> ● The picture is slightly disrupted during fast forward and fast reverse operations. 	<ul style="list-style-type: none"> ● This is not a malfunction.
No sound is heard.	<ul style="list-style-type: none"> ● The volume control of this set is not adjusted properly. ● The player is in a special playback mode. 	<ul style="list-style-type: none"> ● Set the sound volume to an appropriate level. → ● Press the play (▶/II) key to resume normal playback mode. →
The picture does not look good or the picture/sound quality is poor.	<ul style="list-style-type: none"> ● A nearby device is generating noise. ● The disc is dirty. ● The disc is damaged. ● There is condensation on the optical lens. 	<ul style="list-style-type: none"> ● Separate this unit as far as possible from the device you think is generating the noise. ● Refer to the "Disc handling precautions" section and wipe dirt from the disc. → ● Use a new disc. ● Refer to the "Caution on condensation" section and evaporate the condensation. →
It takes a while for the disc to start playing.	<ul style="list-style-type: none"> ● Time is required for the unit to detect the disc type and size and for the rotation of the motor to stabilize. This is not a malfunction. 	<ul style="list-style-type: none"> ● Approximately 10 to 20 seconds are required for a disc to start playing, although the time differs depending on the disc.
The top and bottom of the screen cannot be seen.	<ul style="list-style-type: none"> ● Playback is made with a setting different from the TV aspect ratio. 	<ul style="list-style-type: none"> ● Match the aspect ratio. → →
A VCD cannot be played using menus.	<ul style="list-style-type: none"> ● The VCD disc being played is not compatible with P.B.C. 	<ul style="list-style-type: none"> ● Menu playback is available only with VCD discs recorded with P.B.C.
The subtitle is not displayed.	<ul style="list-style-type: none"> ● The DVD disc being played does not contain the recording of subtitles. ● The subtitle mode is set to off. 	<ul style="list-style-type: none"> ● The subtitle cannot be displayed when the DVD disc being played does not contain the recording of subtitles. → ● Press the S.TITLE key to switch on the subtitle mode. →
The voice (or subtitle) language cannot be changed.	<ul style="list-style-type: none"> ● The DVD disc being played does not contain the recording of more than one audio (or subtitle) language. 	<ul style="list-style-type: none"> ● The voice (or subtitle) language cannot be changed when the DVD disc being played does not contain the recording of more than one voice (or subtitle) language. →

DVD / CD player unit

Symptom	Cause	Remedy
The viewing angle cannot be changed.	<ul style="list-style-type: none"> ● The DVD disc being played does not contain the recording of more than one angle. ● You are attempting to switch the angle in a DVD section where more than one angle is not recorded. 	<ul style="list-style-type: none"> ● The viewing angle cannot be changed when the DVD disc being played does not contain the recording of more than one angle. → 26 ● More than one viewing angle may be recorded only in limited sections in a disc.
A disc can not be played although the region code is displayed as [ALL].	<ul style="list-style-type: none"> ● Some discs can not be played in all regions even when [ALL] is displayed. 	<ul style="list-style-type: none"> ● Play a different disc.
Playback will not start even after a title is selected.	<ul style="list-style-type: none"> ● A viewing restriction (Parental level) has been set for the disc. 	<ul style="list-style-type: none"> ● Check the viewing restriction level (Parental level) setting. → 40
The viewing restriction level (RATING) cannot be changed.	<ul style="list-style-type: none"> ● You have forgotten the viewing restriction (Parental) password. 	<ul style="list-style-type: none"> ● Set the initial setup to the factory setup with the following procedure. With no disc in the unit, press the PLAY/PAUSE (▶/⏸) key. After "NO DISC" is displayed, press the DVD CD key, cursor ▶ key, ◀ key, ▼ key, ▲ key on the remote and ◀◀ key on the main unit in this order. Press the POWER switch to OFF and press the POWER switch again to ON.
The voice or subtitle language selected in the initial setting is not played.	<ul style="list-style-type: none"> ● The DVD disc being played does not contain the recording of the selected voice or subtitle language. 	<ul style="list-style-type: none"> ● Use a DVD disc containing the recording of the selected voice or subtitle language. → 25
No message appears on the TV screen after a key is pressed.	<ul style="list-style-type: none"> ● The function for displaying message on the TV screen is set to off. 	<ul style="list-style-type: none"> ● Set On-screen function to on. → 23
Menu screen messages are not shown in the desired language.	<ul style="list-style-type: none"> ● The menu language function (MENU) is not set. 	<ul style="list-style-type: none"> ● Set the disc menu language function (MENU) as required. → 40

Inhibition icon

Symptom	Cause	Remedy
 The inhibition icon is displayed and remote control is not possible.	<ul style="list-style-type: none"> ● Playback is restricted intentionally by the software producer. 	<ul style="list-style-type: none"> ● The operation is inhibited. Please try another operation. → 9

It is prohibited by laws to duplicate, broadcast, perform in public or rent a disc without the permission of the copyright owners.

This product incorporates copyright protection technology that is protected by method claims of certain U.S. patents and other intellectual property right owned by Macrovision Corporation and other rights owners. Use of this copyright protection technology must be authorized by Macrovision Corporation, and is intended for home and other limited viewing uses only unless otherwise authorized by Macrovision Corporation. Reverse engineering or disassembly is prohibited.

Main unit

Model; DVR-5070

[Amplifier section]

Effective output power during STEREO operation

1 kHz, 10 % T.H.D. at 4 Ω 65 W + 65 W

Effective output power during SURROUND operation at all channel driven

Front (1 kHz, 10 % T.H.D. at 4 Ω) 25 W + 25 W

Center (1 kHz, 10 % T.H.D. at 4 Ω) 25 W

Surround (1 kHz, 10 % T.H.D. at 4 Ω) 25 W + 25 W

Effective output power during SURROUND operation at one channel driven

Left (1 kHz, 10 % T.H.D. at 4 Ω) 65 W

Right (1 kHz, 10 % T.H.D. at 4 Ω) 65 W

Center (1 kHz, 10 % T.H.D. at 4 Ω) 65 W

Left Surround (1 kHz, 10 % T.H.D. at 4 Ω) 35 W

Right Surround (1 kHz, 10 % T.H.D. at 4 Ω) 35 W

Input sensitivity / impedance

VCR, SAT/CABLE, TV, FRONT 700 mV / 68 kΩ

Output level / impedance

VCR 700 mV / 470 Ω

[Tuner section]

FM tuner section

Tuning frequency range 87.5 MHz ~ 108 MHz

AM Tuner section

Tuning frequency range 530 kHz ~ 1,700 kHz

[DVD/CD/VIDEO CD player section]

Laser Semiconductor laser

Wow & Flutter Less than unmeasurable Limit

Video output format NTSC

VIDEO OUTPUT

Composite video output level/impedance 1 Vp-p (75 Ω)

S-video output

Y output level/impedance 1 Vp-p (75 Ω)

C output level/impedance 0.286 Vp-p (75 Ω)

Component video output (only for some areas)

Y output level/impedance 1 Vp-p (75 Ω)

C/b output level/impedance 0.7 Vp-p (75 Ω)

C/r output level/impedance 0.7 Vp-p (75 Ω)

Compression format MPEG1/MPEG2

[DIGITAL AUDIO section]

Sampling frequency 32 kHz, 44.1 kHz, 48 kHz

Input level/impedance/wave length

Optical -15 dBm ~ 21 dBm (660 nm ±30 nm)

Coaxial 0.6 Vp-p (75 Ω)

Digital output -15 dBm ~ 21 dBm

(Wave length 660 nm)

[General]

Power consumption 250 W

Dimensions W: 440 mm (17-5/16")

H: 93 mm (3-11/16")

D: 410 mm (16-1/8")

Weight (net) 8.8 kg (19.4 lbs)

Speaker units

Frequency response (±3 dB) 35 Hz to 20 kHz

Nominal impedance 4 Ω

Maximum system SPL 108 dB (at typical listen position)

Sensitivity [1 watt (2.83 V) at 1 m] 88 dB (SPL)

Crossover frequency 160, 4500 Hz

Subwoofer amplifier power 100 W (RMS at 1% THD+N into 4Ω)

Bass unit 8"

Mid range 3"

Tweeter 3/4"

Dimensions

Center channel W: 187 mm (7-3/8")

H: 114 mm (4-1/2")

D: 116 mm (4-9/16")

Satellites W: 127 mm (5")

H: 165 mm (6-1/2")

D: 124 mm (4-7/8")

Subwoofer W: 356 mm (14")

H: 351 mm (13-13/16")

D: 349 mm (13-3/4")

Weight (net)

Center channel 970 g (2.13 lbs)

Satellites 910 g (2.0 lbs)

Subwoofer 9.1 kg (20 lbs)



1. KENWOOD follows a policy of continuous advancements in development. For this reason specifications may be changed without notice.
2. Sufficient performance may not be possible at very low temperatures (0°C or less).

MEMO



Boston

Boston Acoustics

KENWOOD

For your records

Record the serial number, found on the back of the unit, in the spaces designated on the warranty card, and in the space provided below. Refer to the model and serial numbers whenever you call upon your dealer for information or service on this product.

Model _____ Serial Number _____